



FULL LINE CATALOG

MORE THAN 20 YEARS OF EXPERTISE
IN LIGHTING SOLUTIONS



ledlenser.com



Item no. 502524
V 2.0



MORE THAN 20 YEARS OF EXPERTISE IN LIGHTING SOLUTIONS

When the two brothers Harald and Rainer Opolka from Solingen started out, they really didn't have much more than a garage, an old Atari computer, a set of tools, a drawing pad and around 1000 Deutschmarks of seed capital. Today, the former garage company of both the Ledlenser founders is an internationally operating company and one of the global market leaders in portable lights. The German Ledlenser brand conquered the flashlight market in the year 2000. The approach of equipping a flashlight with an LED instead of a bulb as a light source was absolutely visionary at that point in time. Millions of the "V8 Photon Pump" were sold worldwide and it constituted a new era of portable light – the "P7" achieved the same thing several years later.

To meet our objective as an LED pioneer, we are still using this technological advantage today in the development of new products – particularly in times during which LED lighting has become the norm in so many places and genuine quality is becoming harder and harder to recognize. At the same time, our premise "German Engineering & Design" has guided us from day one and justifies our unique commitment to quality. Ledlenser products give users worldwide the freedom of doing their jobs to the best of their ability or pursuing their passion with devotion – with the best possible light on their side.

CONTENTS

CONTENT CLICKABLE ↓

1

20 YEARS OF LEDLENSER

- 04 ABOUT US
- 08 MILESTONES
- 11 QUALITY
- 11 WARRANTY
- 11 ISO CERTIFICATION

2

- 14 TECHNOLOGY
- 18 LIGHT FUNCTIONS
- 19 IP PROTECTION CLASSES
- 20 RECOMMENDED USAGE

22 INNOVATION

- 24 THE NEW P-SERIES AND THE NEW H-SERIES
- 24 CORE WORK SIGNATURE - the revolutionary concept
- 28 NEW P-SERIES OVERVIEW
- 34 NEW H-SERIES OVERVIEW
- 40 PORTABLE ENERGY
- 43 FLEX7
- 44 FLEX3, FLEX7
- 45 BATTERYBOX7
- 46 LITE WALLET
- 48 LITE WALLET

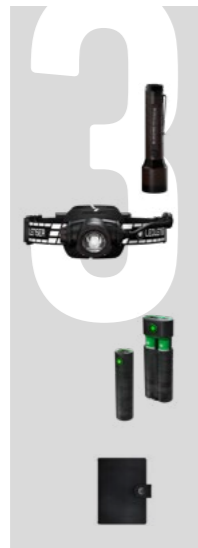

50 HOME & LIFE

- FLASHLIGHTS
- 54 P2R Core NEW
- 54 P4R Core NEW
- 55 P5R Core NEW
- 55 P7 Core NEW
- 57 P6R Core NEW
- 57 P7R Core NEW
- 57 P17R Core NEW
- 58 P6R Core QC NEW
- 60 ACCESSORIES
- P-Series Core NEW

- 64 K1
- 64 K2
- 65 K3
- 65 K4R

- 66 P2
- 67 P3
- 67 P4
- 67 P5

- 68 X21R

70 FLASHLIGHT ACCESSORIES

- HEADLAMPS
- 76 H5 Core NEW
- 76 H5R Core NEW
- 77 H7R Core NEW
- 77 H15R Core NEW
- 77 H19R Core NEW
- 78 ACCESSORIES
- H-Series Core NEW

- 80 H3.2
- 80 H4
- 81 H4R

- 82 SE03
- 82 SE05
- 83 SE07R

84 HEADLAMP ACCESSORIES



86 WORK & PROFESSIONAL

FLASHLIGHTS

- 90 P2R Work NEW
- 90 P4R Work NEW
- 91 P5R Work NEW
- 92 P6R Work NEW
- 92 P7R Work NEW
- 93 P18R Work NEW
- 94 ACCESSORIES
- P-Series Work NEW

- 98 i4
- 98 iL4
- 99 iL7
- 99 iL7R

100 FLASHLIGHT ACCESSORIES

HEADLAMPS

- 107 H5R Work NEW
- 107 H7R Work NEW
- 107 H15R Work NEW
- 108 ACCESSORIES
- H-Series Work NEW

- 110 iLH8
- 110 iLH8R

- 112 iH5
- 112 iH5R
- 114 iH9R
- 114 iH11R

116 HEADLAMP ACCESSORIES

WORKLIGHTS

- 121 iW2R
- 121 iW2R laser
- 121 iW3R
- 124 iW4R
- 124 iW5R flex
- 125 iW5R
- 125 iW7R

FLOODLIGHTS

- 129 iF2R
- 129 iF3R
- 133 iF4R
- 133 iF4R music NEW
- 133 iF8R

INTRINSICALLY SAFE LAMPS

- 140 EX4
- 140 EX7
- 141 EX7R
- 141 EXH8
- 141 EXH8R

142 INTRINSICALLY SAFE LAMPS ACCESSORIES



144 OUTDOOR & SPORTS

FLASHLIGHTS

- 148 P6R Signature NEW
- 148 P7R Signature NEW
- 149 P18R Signature NEW
- 150 ACCESSORIES
- P-Series Signature NEW

- 154 D14.2

HEADLAMPS

- 160 H7R Signature NEW
- 160 H19R Signature NEW
- 162 ACCESSORIES
- H-Series Signature NEW

- 166 MH3 UPDATE
- 166 MH4 UPDATE
- 167 MH5 UPDATE
- 169 MH7 UPDATE
- 169 MH8 UPDATE
- 169 MH11 UPDATE

- 172 NEO4
- 172 NEO6R
- 173 NEO10R

174 HEADLAMP ACCESSORIES

LANTERNS

- 180 ML4
- 180 ML4 Warm Light NEW
- 181 ML6
- 181 ML6 Warm Light
- 181 ML6 Connect WL NEW
- 182 LANTERN ACCESSORIES

7

SERVICE

- 183 INFORMATION
- 184 CONTACT

 **THIS BUTTON ALLOWS YOU TO QUICKLY JUMP FROM EVERY PAGE BACK TO THE TABLE OF CONTENTS**

— ABOUT US



Ledlenser headquarters in Solingen



LEDLENSER THE COMPANY

IT TAKES EIGHT MINUTES FOR THE LIGHT OF THE SUN TO REACH THE EARTH – OURS ONLY TAKES THE PUSH OF A BUTTON

The sun and Ledlenser have something in common: We create light for the whole world! We are devoted to this task with all our energy and capability. The quality products made by Ledlenser prolong daylight and therefore, enable being active when dusk sets in or even during total darkness. They bring light into the darkest corners and in doing so, enable precise and professional work at any time.

KEYPOINTS

- › One of the global market leaders in portable lights. That includes: Flashlights, headlamps, work lights, floodlights, lanterns, EX-protected lamps
- › “German Engineering & Design”: In-house development, production and quality assurance
- › Inventor of the trendsetting and patented³ Advanced Focus System
- › 7-year warranty⁴ for most products in connection with online registration
- › More than 100 industrial property rights as well as more than 200 awards and prizes for our products
- › More than 500 employees worldwide
- › Own locations in Germany, China, USA, Japan, Italy and Switzerland
- › Worldwide collaboration with more than 45 master distributors

¹⁻⁷ Information on page 184

OUR PRODUCTION PLANT IN CHINA

To ensure that our bright ideas see the light of day, we clearly divided up our tasks: “Engineered in Germany, produced in China”. Our production expertise is concentrated at our location in Yangjiang, Guangdong. Every product is manufactured and tested here; from the prototype to mass production.

The checklist for quality control includes 24 tests: Endurance, extreme temperatures, water, salt, blows, pressure and more - inspected and tested until the products have overcome all obstacles and meet our quality standards. Furthermore, it is important to us to take responsibility for our employees in China. We do this for example by building company housing and through our involvement in social and intercultural projects.

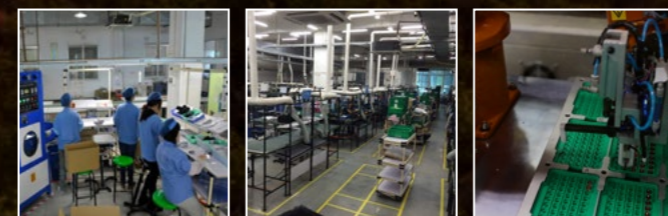

LEDLENSER MILESTONES

2000

LED key ring flashlight **Photonpump V8** is put on the market and sold a million times over



2005

Development of the patented³ **Advanced Focus System**



2011



Ledlenser is included in the **Guinness World Records** with the construction of the world's largest flashlight

2018

With the **new EX products**, Ledlenser launches its first focusable EX-protected flashlights



2020



Ledlenser expands into the "portable energy" sector - **Powerbanks and battery boxes** are the first products in this category

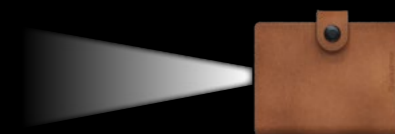

Lite Wallet – the first wallet with 150 lumens¹ is introduced



1993

Company founded by **Harald and Rainer Opolka**



Opening of the company's own **production facility** in Yangjiang, China



2008

Launch of the **legendary P7** – still a bestseller today



Bluetooth

2019

Floodlights and Worklights expand the portfolio for trade and industry

Our first lamps controlled via Bluetooth® conquer the market



Light revolution – launch of the new P-series and H-series in the three versions CORE-WORK-SIGNATURE

^{1,2} Information on page 184

LEDLENSER QUALITY GUARANTEED

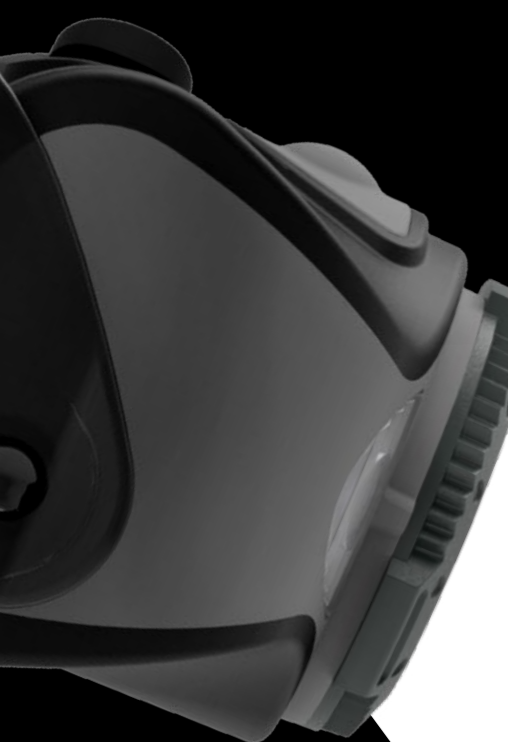

**GERMAN ENGINEERING
& DESIGN**



Management
System
ISO 9001:2015
ISO 14001:2015
ISO 50001:2018

www.tuv.com
ID 9108640713

7
YEAR
WARRANTY*

QUALITY

"German Engineering & Design" - this statement stands for the highest development and production standards in regard to technology, design, materials and workmanship. We hold more than 100 industrial property rights. These include patents, utility models and designs. We are proud of having received various design awards for our products.

WARRANTY

Since we are confident in the quality of our lights, we grant a seven-year warranty on nearly all products in connection with online registration. All original Ledlenser products covered by our warranty include a product registration card. To register, simply scan the QR code with a smartphone or enter the indicated URL on your laptop or PC.

ISO CERTIFICATION

We meet the requirements of the ISO 9001, ISO 14001 and ISO 50001 standards and are certified by TÜV Rheinland.

Quality management: DIN EN ISO 9001:2015

Our systematic quality management ensures a consistently high quality of our products and services. Clearly defined and comprehensible processes enable us to meet our customers' expectations consistently and professionally. We also meet the standard requirements at our Chinese location.

Environmental management: DIN EN ISO 14001:2015

Our company has defined an internal environmental policy and precise environmental objectives. Here, the focus is on the establishment and realization of an environmental management system, to ensure continuous improvements – e.g. in regard to CO₂ emissions, the use of resources and other environmental factors.

Energy management: DIN EN ISO 50001:2018

We operate energy management geared towards sustainability. This includes measures to reduce the consumption of energy such as electricity, gas and fuel as well as specific risk prevention.

^{1,2} Information on page 184



— TECHNOLOGY



 **LEDLENSER**

LEDLENSER TECHNOLOGY-ABC

From innovative lenses and advanced light functions to future-oriented power supplies - we work tirelessly to improve our technology to further expand our lead. Here are some examples:

INNOVATION



MULTI-CORE OPTICS

Multi-Core Optics harness and direct the light emitted from extremely powerful, next-generation LEDs. The special faceted lens tames and directs the light, resulting in a homogeneous beam and aesthetic illumination.



FLEX SEALING TECHNOLOGY

The innovative Flex Sealing Technology ensures that the electronic parts of the lamp head are completely sealed off, to protect against the penetration of water and dust. This flexible system maintains the seal, even when the Advanced Focus System is used. The focus can even be used underwater.



FUSION BEAM

By combining different LEDs and lenses, lamps with Fusion Beam have a unique, application-optimized illumination. This simultaneously enables a homogenous close-up wide flood beam and sharply focused long-distance beam. The intensity of the flood and spot beams can be individually adjusted thanks to independent controls for each light source.



ADVANCED FOCUS SYSTEM (AFS)

Galileo swore by the power of lenses; Newton by the power of reflectors. We have simply combined the two technologies - only better than anyone before. The result: our patented Advanced Focus System (AFS), which allows a seamless transition from homogeneous low beam to sharply focused high beam.

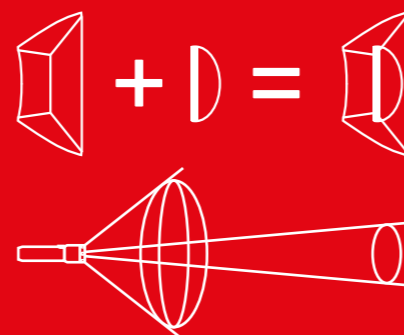

COOLING TECHNOLOGY

Cooling Technology (CT) ensures your head stays cool even when your lamp is at maximum power. Our CT products reduce LED heat to the optimal level by means of the intelligent use of cooling elements. This technology is also used to cool computer chips and ensures highly efficient use of energy, increased illuminating power, and especially long-lasting LEDs.

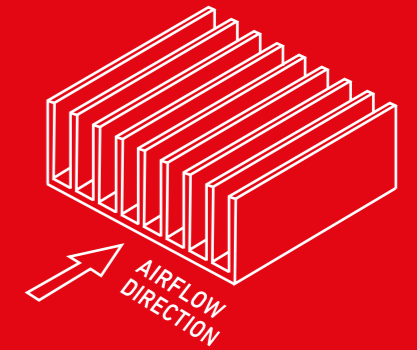

DUAL POWER SOURCE

Our Dual Power Source allows you to use the full performance of your Ledlenser at any time - no matter what power source you have available. Because this technology recognises the power source. You can therefore choose between the rechargeable Ledlenser battery or a disposable battery. Extremely practical for long trips without a power point.

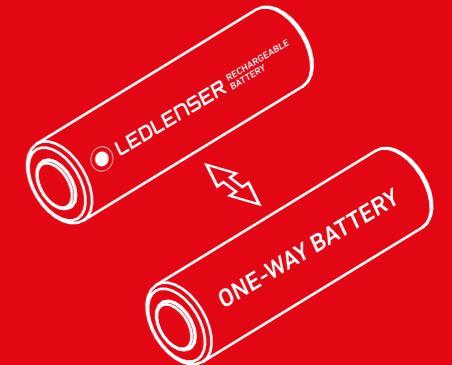

EMERGENCY LIGHT

This feature turns your flashlight into an emergency light: If the power goes out while your Ledlenser is on the charging base, it will automatically turn on. So the light helps you find your way around, e.g. to the breaker panel.

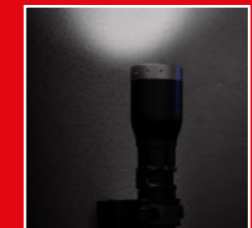

FLOATING CHARGE SYSTEM

Grab-and-go wireless charging. The Floating Charge System is a wall-mounted magnetic charging system, making the light ready to go with a simple flick of the wrist. It also offers USB charging with an adapter system that can be plugged into standard outlets or car lighters.

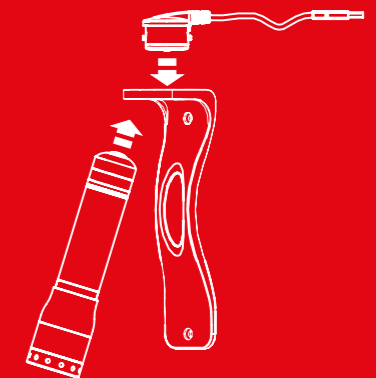

MAGNETIC CHARGE SYSTEM

With the Magnetic Charge System, the charging cable can be quickly and easily attached to the lamp. The connection for charging the battery is made via magnetic contacts. When the contacts approach, the charging cable automatically pairs with the lamp. The connection is automatically released under load.

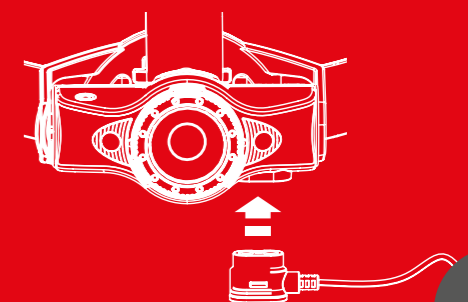

^{1,2} Information on page 184



MICRO PRISM TECHNOLOGY

Our innovative lens technology features an optical microstructure, which provides both glare-free light distribution and high efficiency at the same time. It ensures a downward beam that is up to three times stronger than conventional scattered light lenses and therefore provides optimal light distribution in the room, regardless of whether the light sits on a table or hangs from the ceiling. It creates a brighter view, whether used indoors or outdoors.



NATURAL LIGHT

In some situations, not all light is the same. Ledlenser therefore not only supplies extremely bright, but also extremely natural light: Natural Light produces light with a color rendering index (CRI) over 90. This ensures true color rendering, even in the deep red color range.

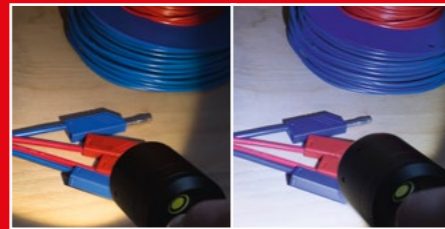

CRI 90, 4000 K

CRI 65, 6500 K



OPTISENSE TECHNOLOGY

Whether it's dusk, dim or pitch black, Optisense Technology allows your Ledlenser to automatically adapt to the surrounding light conditions. The innovative dimmer controls luminosity based on the reflection of its own light and prevents glare.



POWERBANK

Even in the most remote corners of the world, you'll never again have to worry about any device's battery running out. Some Ledlenser Lights have a Powerbank function so they can easily be used as charging stations to recharge any device quickly via a USB connection.

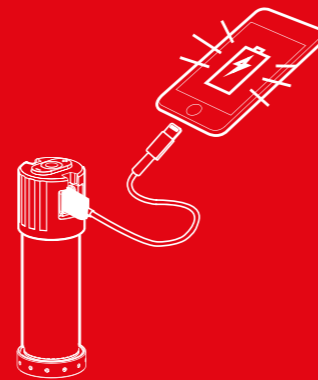

RAPID FOCUS

When focusing or defocusing the flashlight or headlamp, the reflector lens moves in relation to the LED. To ensure this process is as quick and ergonomic as possible we developed Rapid Focus: a single-hand mechanism that allows the light beam to be adjusted as fast as lightning.

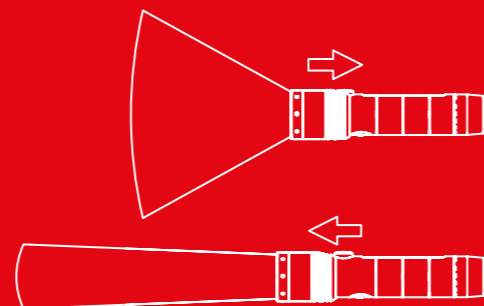

SAFETY YTRION CELL

A Safety Ytrion Cell is significantly lighter than a nickel-metal hydride battery and charges up to five times faster than a lithium-ion battery. At the same time, it offers more than 5000 charging cycles with almost zero loss of capacity "Memory Effect".



SMART LIGHT TECHNOLOGY (SLT)

This innovation turns a Ledlenser into your personal lighting tool: A micro-controller allows individual ranges of functions to be programmed to different touch and switch combinations. That way, you always have the perfect light mode at hand.

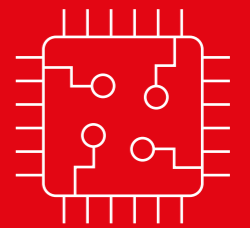

TEMPERATURE CONTROL

Our lights stay cool, even when they work hard. Thanks to the intelligent and fully automated temperature control, a Ledlenser never gets too hot, no matter how much it's used. This protects you from burns and the LED from overheating.



WIDE BEAM

Our wide beam format takes into account that the human field of vision is around 180° degrees horizontally and only around 130° degrees vertically. The oval shape of the light and the Wide Beam technology makes things twice as safe: not only allowing you to see more, but also to be seen from every angle.

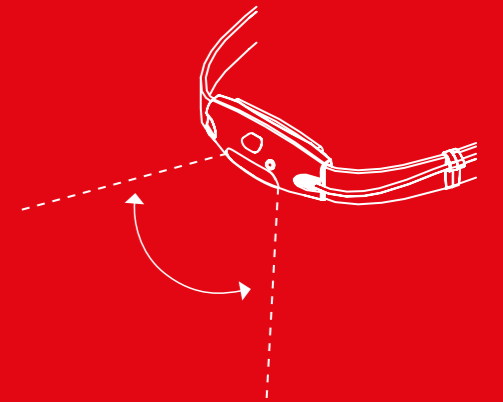

X-LENS TECHNOLOGY

This technology is an enhancement of the Advanced Focus System (AFS). It can merge virtually any number of reflector lenses and synchronizes their individual light beams into a perfect beam, resulting in a high-grade, homogeneous floodlight in unfocused mode and our most sharply focused high beam to date.



^{1,2} Information on page 184



LEDLENSER LIGHT FUNCTIONS



BOOST

A temporary burst of light



POWER

A bright light for any situation



MID POWER

Sufficient light output for extended battery life



LOW POWER

Economical light for long battery life, glare-free reading and working



PULSE

The light intensity keeps rising and decreasing evenly



STROBE

Quick flashes of light with an irritating blinding effect for emergency situations



BLINK

Automatically emits light pulses at regular intervals



POSITION

Regular light pulses at long intervals for position marking



S.O.S.

The light emits an SOS distress signal in morse code (3 x short, 3 x long, 3 x short)

CONSTANT LIGHT

Constant light means the lamp will maintain a more consistent level of brightness. The lamp will not gradually dim as the battery power decreases. As the battery power is diminished, the lamp emits a periodic warning signal. Before shutting down completely, the lamp provides about one hour of residual light in the backup mode.

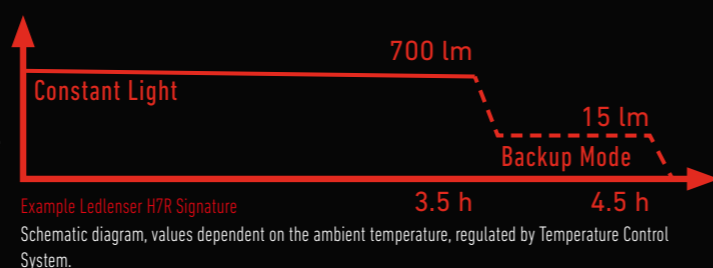

IP RATINGS

IP ratings define the protection of the products against the penetration of foreign particles (mainly dust, dirt) and water. Basically, the following applies: The higher the value, the higher the protection rating. However, there is one caveat: Up to the protection rating IPX6, the lower ratings are automatically included when the protection against the ingress of water is indicated. However, both higher ratings (IPX7 and IPX8) refer to another type of water ingress (submersion under water). That is why the products of our iL and EX series for example comply with the protection ratings IP66 and IP68. That means they are protected against powerful water jets as well as continuous submersion.

We assess the protection ratings of our products in accordance with the internationally recognized DIN EN 60529 standard.

IP TYPE ACCORDING TO EN 60529

IP56

1. Part: Protection against the ingress of foreign particles
2. Part: Protection against the ingress of water

1. PART

PROTECTION AGAINST THE INGRESS OF FOREIGN PARTICLES

- X Not tested
- 0 No protection against the ingress of foreign particles
- 1 Protection against ingress of solid foreign particles with a diameter > 50mm
- 2 Protection against ingress of solid foreign particles with a diameter >12,5mm
- 3 Protection against ingress of solid foreign particles with a diameter > 2,5mm
- 4 Protection against ingress of solid foreign particles with a diameter > 1mm
- 5 Protection against harmful dust deposits at the inside
- 6 Protection against ingress of dust (dust-tight)

2. PART

PROTECTION AGAINST THE INGRESS OF WATER

- X Not tested
- 0 No protection against the ingress of water
- 1 Protection against vertically dripping water
- 2 Protection against dripping water falling at an angle (with 15° incline)
- 3 Protection against splashing water (inclined up to 60°)
- 4 Protection against splashing water (from all directions)
- 5 Protection against water jets (from all directions)
- 6 Protection against strong water jets
- 7 Protection against submersion in water up to 1 meter deep for up to 30 minutes
- 8 Protection against submersion in water up to a specified depth.



LEDLENSER RECOMMENDED APPLICATION

You can find the perfect light for a multitude of applications in our product portfolio. Whether for professional and industrial use, everyday use or for sports and recreational purposes – we supply the customized lighting.

At the same time, our recommendations (symbolized using icons) are intended as a general orientation guide and not as a limitation to these areas of application. For example, our legendary P-series has been popular for years in nearly all imaginable fields of use, far beyond our recommended applications.



HOME & LIFE



HOME



DIY



DOG WALK



EVERYNIGHT



TRAVEL



PHOTOGRAPHY



WORK & PROFESSIONAL



CRAFT



INDUSTRY



POLICE



SECURITY



FIREFIGHTER



MILITARY



MEDICAL



SEARCH & RESCUE



OUTDOOR & SPORTS



MOUNTAINEERING



ACTION



RUNNING



DIVING



BOATING



CARAVANING



CAMPING



HIKING



GEOCACHING



HUNTING



FISHING

— INNOVATION
LIGHT REVOLUTION
THE NEW P-SERIES AND
THE NEW H-SERIES



CORE-WORK-SIGNATURE

The revolutionary concept of the new P-series and H-series.

For many years, people in need of the perfect flashlight for a multitude of applications have trusted our legendary **P-series**. If they needed to combine free hands with perfect illumination, they trusted our **H-series**.

This latest version of our most important product lines is far more than a revision: it is a **revolution in lighting**. With trendsetting new features and technologies, significantly more power and the new **Core – Work – Signature** concept, we are transporting our portfolio into the future and opening it up to many new user groups.

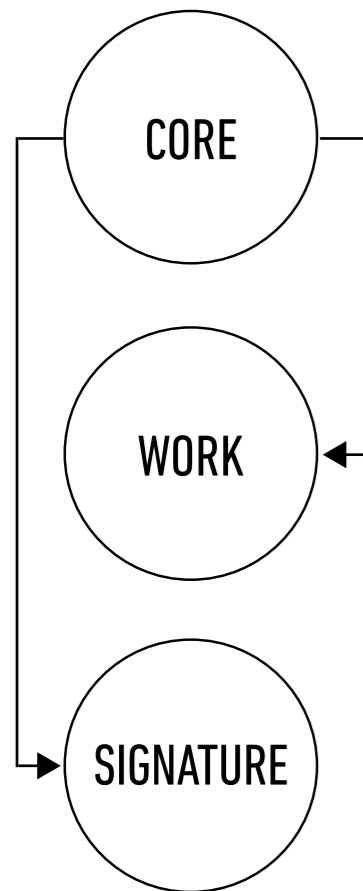

The lights and lamps in the **Core line** form the heart of the new P-series and H-series. They follow the great legacy of the famous P- and H-series and in doing so, combine a proven and tested history with new technology. Core lights are ideally suitable for a **wide range of applications for everyday or on-the-job use** and are distinguished by an excellent price-performance ratio.

The **Work line** lights and lamps are specifically developed for routine applications in challenging work environments. Built on a Core line foundation with additional work-enhancing features, – e.g. **increased protection against blows, drops and chemicals**, optimized light with natural color reproduction as well as a **wide range of helpful accessories included**.

Our **Signature models** represent the premium line of the new P-series and H-series. These **high-end lights and lamps combine all functions** of the Core models with **increased power** and a **larger range of features** as well as a classy design, enhanced materials and a **wide range of accessories included**.



¹⁻³ Information on page 184



Lighting professionals at work

- ▶ extensive package of features and functions
- ▶ excellent light quality and workmanship
- ▶ strong protection against water and dust
- ▶ **robust & durable**
- ▶ **natural color reproduction**
- ▶ **specific accessories included**

FIELDS OF USE

Industry and craftsman, various professional groups



Loyal lights for every day

- ▶ extensive package of features and functions
- ▶ excellent light quality and workmanship
- ▶ strong protection against water and dust
- ▶ **convincing price-performance ratio**

FIELDS OF USE

Recreation, job and everyday life



The perfect light for the highest demands

- ▶ **extensive package of features and functions**
- ▶ excellent light quality and workmanship
- ▶ strong protection against water and dust
- ▶ **use of premium materials**
- ▶ **natural color reproduction**
- ▶ **specific accessories included**

FIELDS OF USE

Outdoor, sport, photography and lifestyle



CORE-WORK-SIGNATURE

Ledlenser Connecting System

Thanks to the **modular design** of this product series, it has never been easier to take advantage of our **extensive range of accessories**. Our new **Ledlenser Connecting System** creates a **universal interface**, which ensures that the respective accessory can be combined with a multitude of flashlights and headlamps. This enables an even more versatile uses and an **expansion of the application options** of our lamps.

More functions & technologies than ever before

Never before have so many features, functions and details been combined into a new product series. That includes a number of new developments, e.g. our patent pending **Flex Sealing Technology** for **maximum protection against dust and water** while maintaining focus ability or **constant, flicker-free light**, which maintains a high degree of brightness over time.



FLEX SEALING TECHNOLOGY

We also revised some of our, existing technologies such as the **Magnetic Charge System** for **easy, reliable and fast charging** and conceived new ones such as the **Smart Light Technology** for complete, **individual programmability of the light functions**.



MAGNETIC CHARGE SYSTEM

Technologies that have existed since the first P-series and H-series, such as our patented³ **Advanced Focus System**, are still used and leave no doubt that the new series are genuine Ledlenser products.



SMART LIGHT TECHNOLOGY

And the most important thing: every user will find **the perfect light for their purpose** among the models of the new P-Series and H-Series.



ADVANCED FOCUS SYSTEM

¹⁻² Information on page 184



THE NEW P-SERIES

A P FROM LEDLENSER IS ALWAYS A STATEMENT

The robust and reliable flashlights of the new P-series offer an impressive package of features in a stylish design.

Furthermore, the P-series is the first modularly designed Ledlenser flashlight series. In the Core, Work and Signature versions, each of the lights are customized for different target groups from everyday users to professionals in trade and industry to outdoor enthusiasts.

P7R CORE

THE BASE MODEL

☀ 1400 lm¹
 ↗ 300 m¹
 ⌚ 90 h¹



- 01 – **Multi-Core Optics** – homogeneous beam made possible by special faceting of the lens
- 02 – **Advanced Focus System** – stepless focusing
- 03 – Extreme **dust and water protection (IP68)**
- 04 – **Flex Sealing Technology** – can be used for a short time underwater (including the focusing system) to a depth of one meter
- 05 – Personalize the light functions thanks to **Smart Light Technology**
- 06 – **Constant Light** – consistent level of brightness over time
- 07 – **Flicker-free** – flicker-free, constant light enables optimal and safe illumination of fast-moving parts and machines
- 08 – Convenient and safe charging of the battery thanks to the **Magnetic Charge System**
- 09 – Integrated **battery and charge status display**

Contents: 1 battery pack, lanyard, magnetic charging cable

P7R WORK

THE ROBUST MODEL

☀ 1200 lm¹
 ↗ 240 m¹
 ⌚ 60 h¹

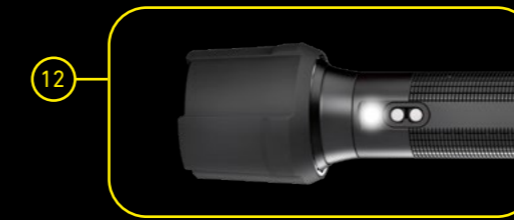

The P7R Work has all characteristics of the P7R Core with additional features and accessories for professional use

- 10 – **Protective elements on the lamp head and the end cap** absorb impacts and increase slip resistance; **the additional front lens cover** protects the lens from scratching
- 11 – **Neutral white light** with natural **Color rendering (CRI 90)**
- 12 – **Secondary white light** on the side of the housing for diffuse illumination at close range
- 13 – **Robust charging station** - suitable for installation in a vehicle and compatible with the 5 station charging panel

Contents: 1 battery set, charging station, belt pouch, adjustable lanyard, intelligent clip, magnetic charging cable, USB power adapter

P7R SIGNATURE

THE PREMIUM MODEL

☀ 2000 lm¹
 ↗ 330 m¹
 ⌚ 90 h¹



The P7R Signature has all characteristics of the P7R Core with additional premium features and includes a more extensive range of accessories

- 14 – **Mode Switch** for direct access to personalized Light functions thanks to Smart Light Technology
- 15 – **Secondary red light** on the side of the housing, e.g. to maintain night vision in the dark
- 16 – **Hard anodized housing** for additional protection against wear and corrosion
- 17 – **Natural color rendering (CRI 80)**
- 18 – Practical **pocket clip** - also serves as roll protection

Contents: 1 battery set, leather belt pouch, adjustable lanyard, magnetic charging cable, pocket clip, USB power adapter, wall mount



THE NEW P-SERIES

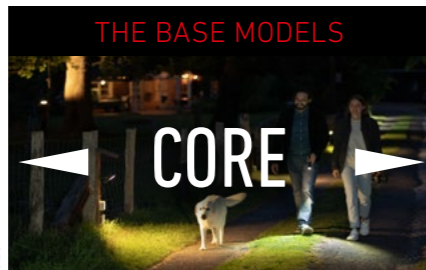

available from October 1st, 2020 available from October 1st, 2020

available from October 1st, 2020 available from October 1st, 2020

P2R WORK **34,90 €**
Item no. 502183

Luminous flux **110 lm¹** CRI **80** Color temp. **4300 K** Drop height **2 m**

P2R CORE **24,90 €**
Item no. 502176

Luminous flux **120 lm¹** CRI **70** Color temp. **6500 K** Drop height **2 m**

P4R WORK **44,90 €**
Item no. 502184

Luminous flux **170 lm¹** CRI **80** Color temp. **4300 K** Drop height **2 m**

P4R CORE **34,90 €**
Item no. 502177

Luminous flux **200 lm¹** CRI **70** Color temp. **6500 K** Drop height **2 m**

P5R WORK **69,90 €**
Item no. 502185

Luminous flux **480 lm¹** CRI **70** Color temp. **4000 K** Drop height **3 m**

P7 CORE **69,90 €**
Item no. 502180

Luminous flux **450 lm¹** CRI **70** Color temp. **6500 K** Drop height **1 m**

P5R CORE **59,90 €**
Item no. 502178

Luminous flux **500 lm¹** CRI **70** Color temp. **6500 K** Drop height **2 m**

P6R WORK **99,90 €**
Item no. 502186

Luminous flux **850 lm¹** CRI **90** Color temp. **4000 K** Drop height **3 m**

P6R CORE **79,90 €**
Item no. 502179

Luminous flux **900 lm¹** CRI **65** Color temp. **6500 K** Drop height **2 m**

P6R SIGNATURE **129,00 €**
Item no. 502189

Luminous flux **1400 lm¹** CRI **80** Color temp. **6500 K** Drop height **2 m**

P7R WORK **129,00 €**
Item no. 502187

Luminous flux **1200 lm¹** CRI **90** Color temp. **4000 K** Drop height **3 m**

P7R CORE **99,90 €**
Item no. 502181

Luminous flux **1400 lm¹** CRI **70** Color temp. **6500 K** Drop height **2 m**

P7R SIGNATURE **159,00 €**
Item no. 502190

Luminous flux **2000 lm¹** CRI **80** Color temp. **6500 K** Drop height **2 m**

P17R CORE **199,00 €**
Item no. 502182

Luminous flux **1200 lm¹** CRI **65** Color temp. **6500 K** Drop height **1 m**

P18R WORK **249,00 €**
Item no. 502188

Luminous flux **4500 lm¹** CRI **70** Color temp. **5000 K** Drop height **1 m**

P18R CORE **249,00 €**
Item no. 502191

Luminous flux **4500 lm¹** CRI **70** Color temp. **6500 K** Drop height **1 m**

P18R SIGNATURE **249,00 €**
Item no. 502191

Luminous flux **4500 lm¹** CRI **70** Color temp. **6500 K** Drop height **1 m**

¹⁻⁷ Information on page 184



ICONS OF LIGHT

INNOVATION



THE NEW P-SERIES

LEDLENSER CONNECTING SYSTEM

As a newly created interface, the Ledlenser Connecting System makes it easy, to connect the flashlights of the new P-series and their accessories with a simple click. It allows our lamps to transform into a variety of uses. Simply clip the lamp adapter to the shaft of the light, attach the suitable accessory, and you're ready to go.

And, above all: The Ledlenser Connecting System works across the new P-series and even the headlamps in the new H-series. One accessory can be used with different kinds of products for convenience and cost savings.

Light Adapter
Mounting adapter - the Ledlenser connecting system
4,90 € (MSRP)



Item no. 502253
Belt Clip Type A
Belt clip for lights and battery packs - the lamp can be rotated 360° and thus becomes a flexible, hands-free. **6,90 € (MSRP)**



Light Adapters are available in these sizes:

P2R Core/Work, P4R Core/Work:
Light Adapter Type A
Item no. 502248

P5R Core
Light Adapter Type B
Item no. 502249

P6R Core/Signature:
Light Adapter Type C
Item no. 502250

P7R Core/Signature:
Light Adapter Type D
Item no. 502251

Note: The P5R Work, P6R Work and P7R Work, already include a light adapter.

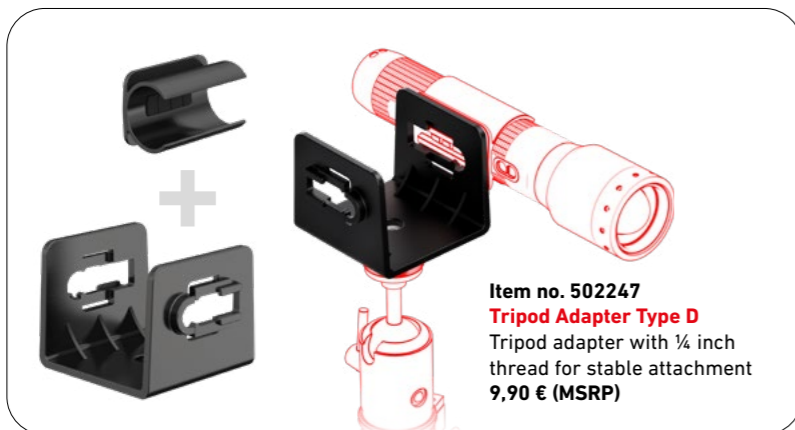

Item no. 502247
Tripod Adapter Type D
Tripod adapter with 1/4 inch thread for stable attachment
9,90 € (MSRP)

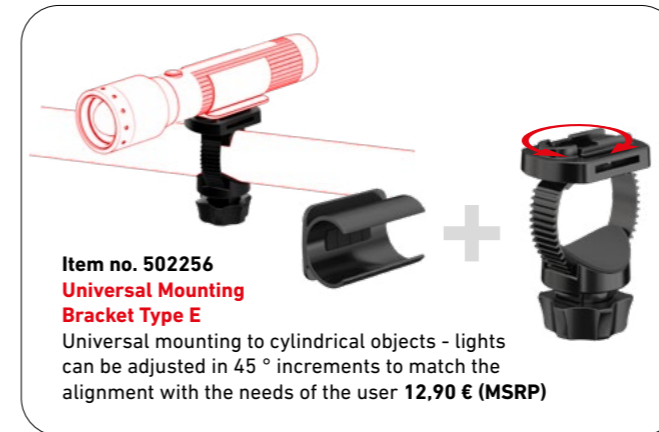

Item no. 502256
Universal Mounting Bracket Type E
Universal mounting to cylindrical objects - lights can be adjusted in 45° increments to match the alignment with the needs of the user **12,90 € (MSRP)**

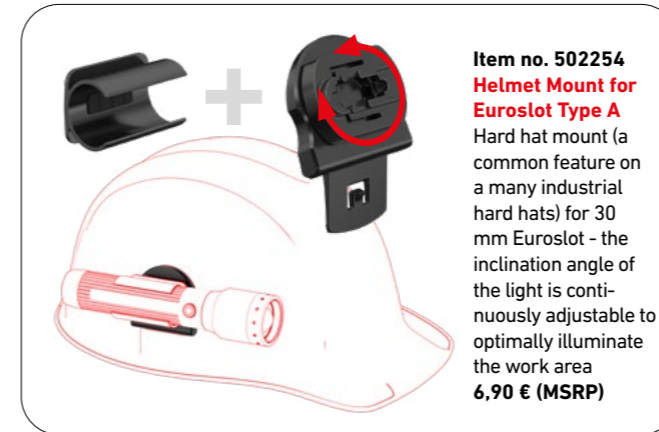

Item no. 502254
Helmet Mount for Euroslot Type A
Hard hat mount (a common feature on a many industrial hard hats) for 30 mm Euroslot - the inclination angle of the light is continuously adjustable to optimally illuminate the work area **6,90 € (MSRP)**



Item no. 502246
GoPro Adapter Type D
Compatible with almost all GoPro-compatible systems and accessories - e.g. rotary clip, suction cup or handlebar mount **7,90 € (MSRP)**



Item no. 502255
Flexible Mount Type A
Flexible fastening system with a magnetic base, adhesive pads and a hole for attachment with a screw. The lamp can be rotated (360° horizontally and vertically). **14,90 € (MSRP)**

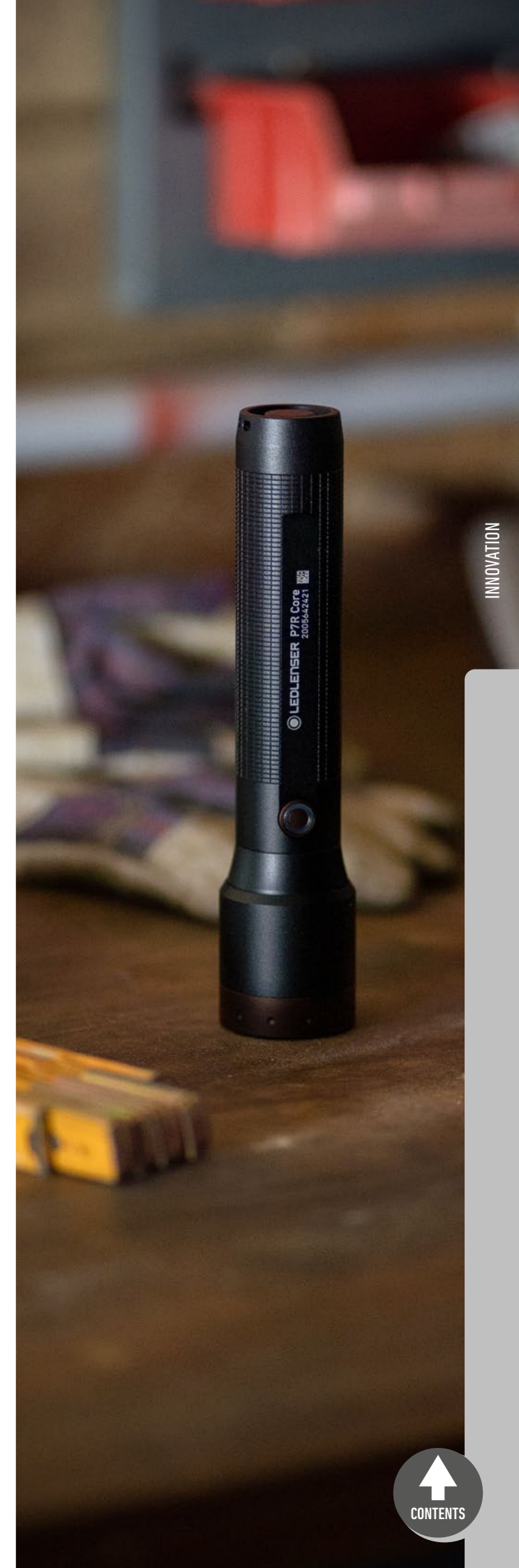

INNOVATION

THE NEW H-SERIES

THE NEW H-SERIES - A CROWNING ACHIEVEMENT

As trusted providers of light for countless uses, our H-series headlamps are indispensable at home, at work or in the wilderness.

Intuitive operation, robust design, and fantastic illumination are the trademarks of this series – in addition to numerous features and technologies. The best light for nearly every application when hands must remain free can be found in the Core, Work and Signature series whether for sports, recreational or occupational purposes.

H7R CORE

THE BASE MODEL

☀️ 1000 lm¹
 ↗️ 250 m¹
 ⌚ 65 h¹



- 01 – **Advanced Focus System** – stepless focusing
- 02 – Extreme **dust and water protection (IP67)**
- 03 – **Flex Sealing Technology** – can be used for a short time underwater (including the focusing system) to a depth of one meter
- 04 – Intuitive operation and stepless dimming thanks to **Wheel switch** on the lamp head
- 05 – Stepless **swivel mechanism** for vertical alignment of the light cone
- 06 – **Constant Light** – consistent level of brightness over time
- 07 – **Flicker-free** – flicker-free, constant light enables optimal and safe illumination of fast-moving parts and machines
- 08 – Convenient and safe charging of the battery thanks to the **Magnetic Charge System**

Contents: 1 battery pack, magnetic charging cable

H7R WORK

THE ROBUST MODEL

☀️ 1000 lm¹
 ↗️ 250 m¹
 ⌚ 60 h¹



The H7R Work has all the features of the H7R Core with additional features and accessories for professional use

- 09 – Extremely powerful, focusable headlamp for work: **high color rendering, neutral white light**
- 10 – **Innovative Mounting System** enables easy removal and replacement of the lamp head and the battery for maximum flexibility (also available with H7R Core and H7R Signature)
- 11 – **Protective elements over the lens and battery** for high resistance to all types of impact
- 12 – **Microbe resistant material** - comfortable to wear and easy to clean

Contents: 1 battery set, magnetic charging cable, fastening clips for safe helmet mounting, focusing ring, transparent silicone tape, belt clip, extension cable

H7R SIGNATURE

THE PREMIUM MODEL

☀️ 1200 lm¹
 ↗️ 260 m¹
 ⌚ 65 h¹

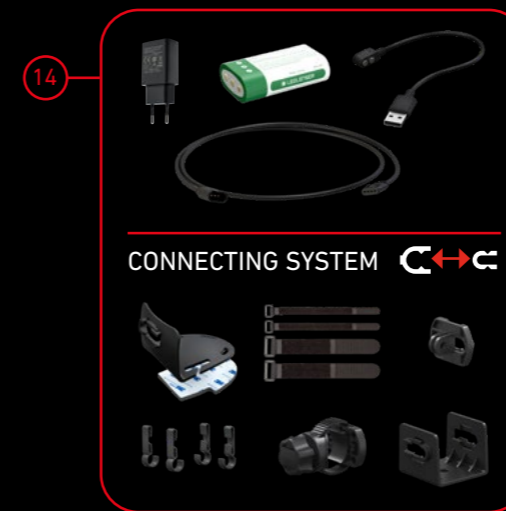

The H7R Signature has all the features of the H7R Core with additional premium features and expanded content

- 13 – **Ledlenser Connect App** enables personalization and remote control of the light functions
- 14 – **Wide range of accessories included**
- 15 – **Reflective headband** for optimal visibility

Contents: 1 battery set, fastening clips for safe helmet mounting, GoPro adapter, helmet holder, velcro fasteners, magnetic charging cable, tripod holder, USB power adapter, universal holder, extension cable, soft case transport bag



THE NEW H-SERIES

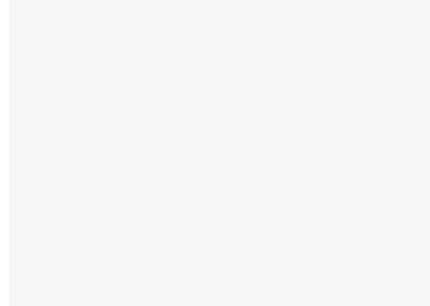
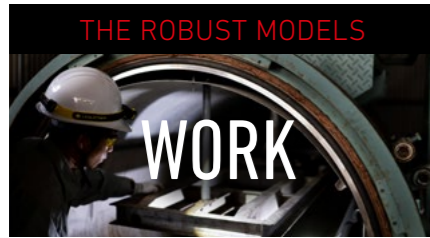

H5 CORE **49,90 €**
Item no. 502193



Luminous flux CRI Color temp. Drop height
350 lm¹ 70 6500 K 1,5 m

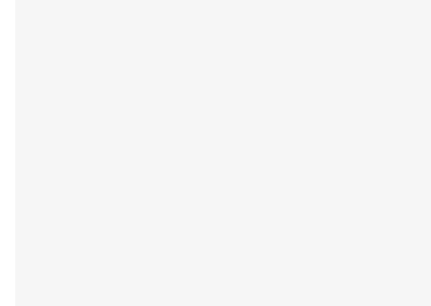

H5R WORK **89,90 €**
Item no. 502194



Luminous flux CRI Color temp. Drop height
500 lm¹ 80 4000 K 3 m

rechargeable

H5R CORE **69,90 €**
Item no. 502121



Luminous flux CRI Color temp. Drop height
500 lm¹ 70 6500 K 1,5 m

rechargeable

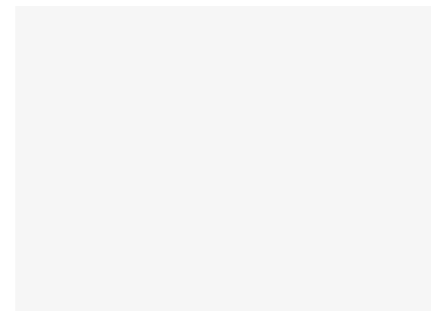

H7R WORK **119,00 €**
Item no. 502195



Luminous flux CRI Color temp. Drop height
1000 lm¹ 90 4000 K 3 m

rechargeable

H7R CORE **89,90 €**
Item no. 502122



Luminous flux CRI Color temp. Drop height
1000 lm¹ 70 6500 K 1,5 m

rechargeable

H7R SIGNATURE **149,00 €**
Item no. 502197



Luminous flux CRI Color temp. Drop height
1200 lm¹ 80 6500 K 1,5 m

Bluetooth rechargeable

H15R WORK **189,00 €**
Item no. 502196



Luminous flux CRI Color temp. Drop height
2500 lm¹ 90 4000 K 3 m

rechargeable

H15R CORE **159,00 €**
Item no. 502123



Luminous flux CRI Color temp. Drop height
2500 lm¹ 70 6500 K 1,5 m

rechargeable

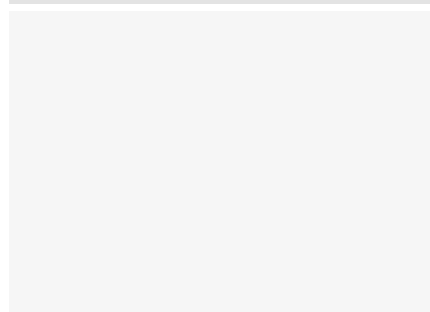
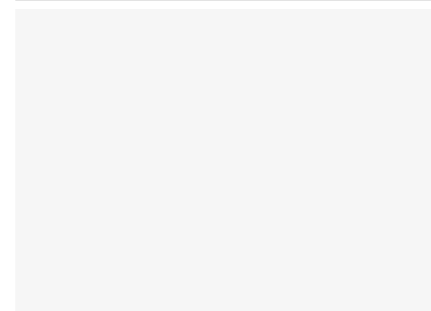

H19R CORE **199,00 €**
Item no. 502124



Luminous flux CRI Color temp. Drop height
3500 lm¹ 70 6500 K 1,5 m

rechargeable

H19R SIGNATURE **299,00 €**
Item no. 502198



Luminous flux CRI Color temp. Drop height
4000 lm¹ 80 6500 K 1,5 m

Bluetooth rechargeable

THE CROWN OF LIGHT



INNOVATION

^{1,2} Information on page 184

THE NEW H-SERIES

LEDLENSER CONNECTING SYSTEM

Like the new P-series, the headlamps of the new H-series can also be connected to an extensive selection of accessories thanks to the Ledlenser Connecting System.

The lamp head and rechargeable battery can each be quickly detached and easily connected to the suitable accessory via a coupling mechanism.



Item no. 502314
Helmet Connecting Kit H

Stable and easy installation of the matching headlamp on a wide variety of helmets (e.g. bicycle helmets, workhard hats, etc.). If the helmet contains vents (like a bicycle helmet) the system can be quickly attached with Velcro fasteners. Alternatively, strong adhesive pads can be used. **14,90 € (MSRP)**



Item no. 502256
Universal Mounting
Bracket Type E

Universal mounting to cylindrical objects - lights can be adjusted in 45° increments to match the alignment with the needs of the user **12,90 € (MSRP)**

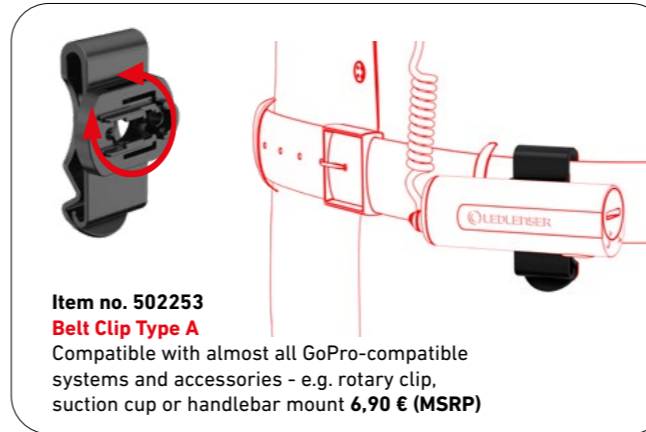

Item no. 502253
Belt Clip Type A

Compatible with almost all GoPro-compatible systems and accessories - e.g. rotary clip, suction cup or handlebar mount **6,90 € (MSRP)**



Item no. 502246
GoPro Adapter Type D

Suitable for almost all GoPro compatible systems and accessories **7,90 € (MSRP)**



Item no. 502247
Tripod Adapter Type D

Tripod adapter with 1/4 inch thread for stable attachment **9,90 € (MSRP)**



NEUHEITEN

— INNOVATION PORTABLE ENERGY FLEX-SERIES

TAKE OFF INTO THE FUTURE OF PORTABLE ENERGY

Many of our lamps are not only known for their outstanding light output but also for their efficient energy management. Furthermore, we developed intelligent charging systems such as the Magnetic Charge System and the Floating Charge System.

Using this know-how, acquired over years, we continue to expand our product portfolio. In addition to portable light, Ledlenser can now supply portable energy.

 **LEDLENSER**

NEW

THE NEW LEDLENSER POWERBANK CONCEPT

Flexible, sustainable, powerful – that distinguishes our new Flex series; the ideal addition for all outdoor activities. The rechargeable batteries of the new Ledlenser powerbanks Flex3 and Flex7 can be removed at any time and are easy to swap out after being drained. Therefore, the powerbanks can charge the 18650 batteries used in compatible Ledlenser lamps and in other electronic devices.

The new Batterybox7 enables the safe transport of two 18650 rechargeable batteries and protects, just like the Flex3 and Flex7, against water, dust and short circuits during harsh outdoor activities.

Can be used for:

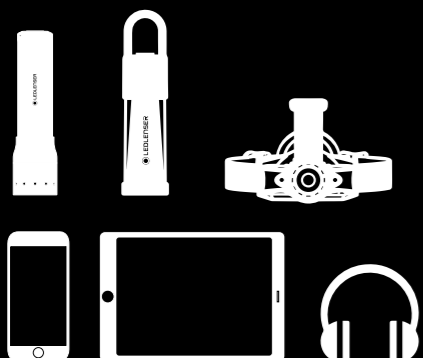

FLEX7 rechargeable

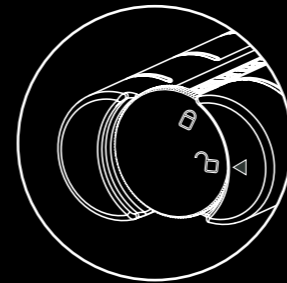

Lock-unlock wheel for maximum security

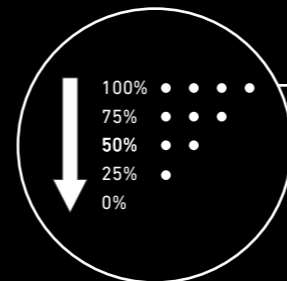

Separate Charge level indicators

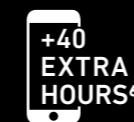

Powerbank – NEW portable power! Innovative 6-in-1 system

The Flex7 is more than just a Powerbank. Apart from the powerbank function, the included 18650 rechargeable batteries can also be safely stored, transported, charged, capacity tested inside the housing, and are removable.



Micro-USB cable included

INNOVATION

¹⁻⁷ Information on page 184



FLEX-SERIES NEW



FLEX3

FLEX7

TECHNICAL SPECS	Powerbank+	Powerbank+
↗ Length (mm)	109	109
↔ Width (mm)	27	47
↑↓ Height (mm)	27	27
⚖ Weight with battery (g / oz)	88 / 3,1	164 / 5,8
⚖ Weight without battery (g / oz)	40 / 1,4	116 / 4,1
TECHNOLOGY		
🔋 Battery	1x 18650 Li-ion Battery 3,6V	2x 18650 Li-ion Battery 3,6V
🔋 Battery Capacity ² (Wh / mAh)	12,34 / 3400	24,68 / 6800
☁ IP Level	IP65	IP65
🔌 Rechargeable	Yes	Yes
🕒 Charging Time ⁵ (min)	240	240
Energy status indicator	Battery Indicator, Charge Indicator, Low Battery Warning	Battery Indicator, Charge Indicator, Low Battery Warning
FEATURES		
	6-IN-1	6-IN-1
	<ol style="list-style-type: none"> Powerbank with a fast replaceable battery Water and dust protection (IP65) Battery charger Safe battery storage Double protection against short circuit (box and battery) Charge level indicator for the battery 	<ol style="list-style-type: none"> Powerbank with fast replaceable batteries Water and dust protection (IP65) Battery charger Safe battery storage Double protection against short circuit (box and battery) Charge level indicator for both batteries
MATCHES		
Ledlenser lights	iH11R, MH11, MH10, NEO10R, ML6, ML6 Warm Light, ML6 Connect WL, P6R Core, P6R Signature, P6R Work	iH11R, MH11, MH10, NEO10R, ML6, ML6 Warm Light, ML6 Connect WL, P6R Core, P6R Signature, P6R Work
PACKAGING		
Item no. Box / GTIN	502126 / 4058205019255	502125 / 4058205019224
Contents Box	1 Battery, USB cable	2 Batteries, USB cable
Price (MSRP) in €	34,90	54,90

¹⁻³ Information on page 184



BATTERYBOX7

Battery transport box

81
56
25
133 / 4,7
85 / 3,0
2x 18650 Li-ion Battery 3,6V
24,68 / 6800
IP65
No (Supplied batteries: Yes)
-
-

1. Safe **battery storage**
2. Water and dust protection (**IP65**)
3. **Protection against short circuit**

iH11R, MH11, MH10, NEO10R, ML6, ML6 Warm Light, ML6 Connect WL, P6R Core, P6R Signature, P6R Work

502128 / 4058205019118

2 Batteries

29,90

— INNOVATION
LITE WALLET®



INNOVATION



LITE WALLET

- 01 – Brighter than the usual smartphone lamps
- 02 – Multiple slots for up to nine cards
- 03 – Small, handy LED lamp with two light intensities and precise optics in mini format
- 04 – Integrated RFID blocker under the metal cover to protect personal data (up to six cards)
- 05 – Another slot for banknotes
- 06 – Easy charging with a wireless charging station or USB-C cable

☀️ 150 lm¹
⌚ 12 h¹



Original size / Classic Black



LED	
⚡ LED-Configuration	Power LED
🔊 Light Functions	Power / Low Power
☀️ Luminous flux ¹ (lm)	150 / 10
🕒 Run Time ¹ (h)	1,5 / 12
BATTERY AND CASE	
🔋 Battery	Li-ion Battery Pack 3,7V
🔋 Battery Capacity ² (Wh / mAh)	2,77 / 750
🔌 Rechargeable	Yes
🕒 Charging Time ⁵ (min)	150
SIZE AND WEIGHT	
📏 Siye LxBxH (mm)	96,5x74x24
📖 Weight incl. Batterys (g / oz)	115 / 4,1
TECHNOLOGY	
Features	Charge Indicator, Battery Indicator, Wireless Charging
PACKAGING / COLOR	
Item no. / GTIN	
Box / Classic Black	502315 / 4058205024013
Box / Classic Chestnut	502326 / 4058205024198
Box / Classic Midnight Blue	502397 / 4058205024679
Box / Classic Caramel	502396 / 4058205024648
Box / Matte Deep Wine	502399 / 4058205024730
Box / Matte Dark Forest	502398 / 4058205024709
Box / Matte Taupe Grey	502401 / 4058205024792
Box / Vintage Brown	502400 / 4058205024761
Contents	USB cable
Price (MSRP) in €	69,90

^{1,2} Information on page 184



NEW

THE FIRST WALLET WITH 150 LUMEN¹

The Ledlenser Lite Wallet is the practical everyday companion for your trouser or jacket pocket. The cardholder arranges identity cards, driver's license, credit cards, or banknotes.

Thanks to the integrated RFID protection, sensitive data is always safe. Integrated into the fine leather wallet is a power LED lamp with up to 150 lumens¹ of light output and homogeneous light distribution. The battery can be charged either wirelessly via a wireless charging station or using a USB-C cable.



Classic Chestnut



Classic Midnight Blue



Classic Caramel



Matte Deep Wine



Matte Dark Forest



Matte Taupe Grey



Vintage Brown

OUR LITE WALLET IN YOUR FAVORITE COLOR

INNOVATION



HOME & LIFE FLASHLIGHTS



 LEDLENSER



P7R CORE



NEW

THE NEW P-SERIES
A CLASSIC BECOMES
A GENUINE BESTSELLER



☀️ 1400 lm¹
🔦 300 m¹
🕒 90 h¹



- 01 – Extreme **dust and water protection (IP68)**
- 02 – **Advanced Focus System** – stepless focusing
- 03 – **Flex Sealing Technology** – can be used for a short time underwater (including the focusing system) to a depth of one meter
- 04 – **Multi-Core Optics** – homogeneous beam made possible by special faceting of the lens
- 05 – Personalize the light functions thanks to **Smart Light Technology**
- 06 – Integrated **battery and charge status display**
- 07 – Convenient and safe charging of the battery thanks to the **Magnetic Charge System**

P-SERIES CORE NEW



	P2R CORE	P4R CORE
LED		
LED-Configuration	1x Power LED	1x Power LED
Light Functions	Power / Mid Power / Low Power	Power / Mid Power / Low Power
Luminous flux ¹ (lm)	120 / 50 / 15	200 / 90 / 15
Beam Distance ¹ (m)	65 / 45 / 15	90 / 60 / 15
Run Time ¹ (h)	0,5 / 1 / 5	1,5 / 3 / 25
Color temperature (K)	6000 - 7500	6000 - 7500
Color rendering index (CRI)	70	70
BATTERY AND CASE		
Battery	1x Li-ion Battery 3,7V mit Mikro-USB	1x Li-ion Battery 3,7V mit Mikro-USB
Battery Capacity ² (Wh / mAh)	0,74 / 200	2,22 / 600
IP Level	IP54	IP54
Rechargeable	Yes	Yes
Charging Time ⁵ (min)	150	150
Drop height (m)	2	2
SIZE AND WEIGHT		
Length – defocused (mm)	103	150
Head diameter (mm)	15	15
Weight incl. Battery (g / oz)	36 / 1,3	55 / 1,9
TECHNOLOGY		
Smart Light Technology		
Flex Sealing Technology		
Magnetic Charge System		
Temperature Control		
Advanced Focus System	●	●
More features	Energy Saving	Energy Saving
PACKAGING		
Item no. Box / GTIN	502176 / 4058205020367	502177 / 4058205020398
Contents Box	1 battery set, pocket clip, USB charging cable	1 battery set, pocket clip, USB charging cable
Price (MSRP) in €	24,90	34,90
OPTIONAL ACCESSORIES		
	0389 USB Power Supply and Cable	0389 USB Power Supply and Cable
more accessories on page 60	502248 Lamp Adapter Type A NEW	502248 Lamp Adapter Type A NEW



	P5R CORE	P7 CORE
LED		
LED-Configuration	1x High Power LED	1x Power LED
Light Functions	Boost / Power / Mid Power / Low Power (+ Position, Blink, S.O.S., Strobe)	Power / Mid Power / Low Power
Luminous flux ¹ (lm)	500 / 350 / 130 / 15	450 / 250 / 40
Beam Distance ¹ (m)	250 / 180 / 110 / 40	300 / 220 / 100
Run Time ¹ (h)	- / 1 / 3,5 / 25	1 / 2 / 25
Color temperature (K)	6000 - 7500	6000 - 7500
Color rendering index (CRI)	70	70
BATTERY AND CASE		
Battery	1x 14500 Li-ion Battery 3,7V	4x Micro (AAA) Alkaline 1,5V
Battery Capacity ² (Wh / mAh)	2,77 / 750	
IP Level	IP68	IP54
Rechargeable	Yes	No
Charging Time ⁵ (min)	120	
Drop height (m)	2	1
SIZE AND WEIGHT		
Length – defocused (mm)	123	130
Head diameter (mm)	29	37
Weight incl. Battery (g / oz)	106 / 3,7	175 / 6,2
TECHNOLOGY		
Smart Light Technology	●	
Flex Sealing Technology	●	
Magnetic Charge System	●	
Temperature Control	●	
Advanced Focus System	●	●
More features	Dimmable, Transportation Lock, Flicker-free, Memory Mode, Backup Mode, Emergency Light, Battery Indicator, Charge Indicator, Low Battery Warning	Energy Saving, Rapid Focus
PACKAGING		
Item no. Box / GTIN	502178 / 4058205020428	502180 / 4058205020480
Contents Box	1 battery set, lanyard, magnetic charging cable	1 battery set, lanyard
Price (MSRP) in €	59,90	69,90
OPTIONAL ACCESSORIES		
	502259 Charging Station Type A	500981 4xAAA Alkaline Battery
	502248 Lamp Adapter Type B NEW	100879 Color Filter Set 37mm

¹⁻⁷ Information on page 184

P5R CORE

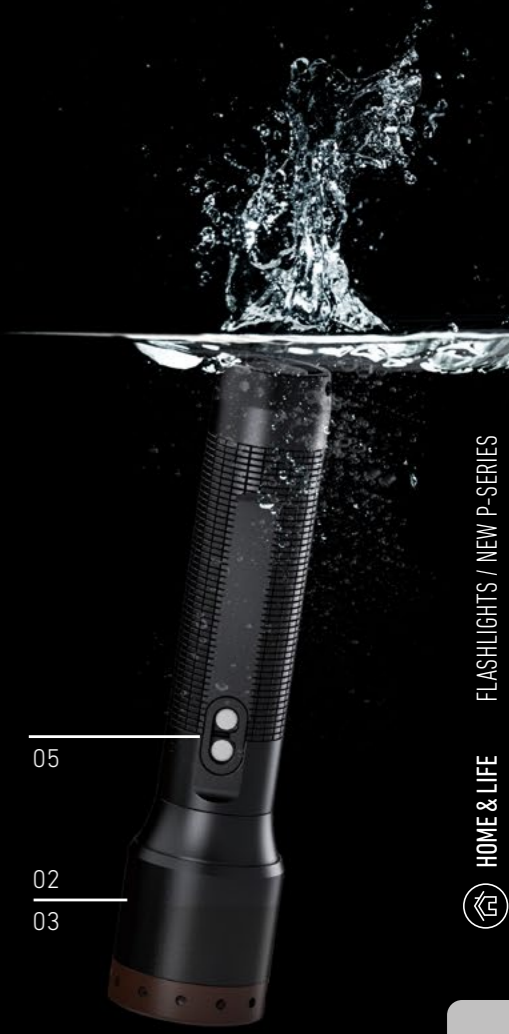

- 01 – Extreme dust and water protection (IP68)**
- 02 – Advanced Focus System** – stepless focusing
- 03 – Flex Sealing Technology** – can be used for a short time underwater (including the focusing system) to a depth of one meter
- 04 – Personalize the light functions thanks to Smart Light Technology**
- 05 – Convenient and safe charging the battery thanks to the Magnetic Charge System**



P-SERIES CORE

NEW



LED

LED-Configuration

Light Functions

Luminous flux¹ (lm)

Beam Distance¹ (m)

Run Time¹ (h)

Color temperature (K)

Color rendering index (CRI)

BATTERY AND CASE

Battery

Battery Capacity² (Wh / mAh)

IP Level

Rechargeable

Charging Time⁵ (min)

Drop height (m)

SIZE AND WEIGHT

Length – defocused (mm)

Head diameter (mm)

Weight incl. Battery (g / oz)

TECHNOLOGY

Smart Light Technology

Flex Sealing Technology

Magnetic Charge System

Multi Core Optics

Advanced Focus System

More features

PACKAGING

Item no. Box / GTIN

Contents Box

Price (MSRP) in €

OPTIONAL ACCESSORIES

more accessories on page 60



P6R CORE

P7R CORE

P17R CORE

1x Xtreme LED

Boost / Power / Mid Power / Low Power
(+ Position, Blink, S.O.S., Strobe)

900 / 600 / 240 / 15

240 / 190 / 120 / 25

- / 2 / 6 / 95

6000 - 7500

65

1x18650 Li-ion Battery 3,7V

9,25 / 2500

IP68

Yes

300

2

151

35

170 / 6,0

•

•

•

•

•

Dimmable, Transportation Lock, Flicker-free, Memory Mode, Backup Mode, Emergency Light, Temperature Control System, Battery Indicator, Charge Indicator, Low Battery Warning

502179 / 4058205020459

1 battery set, lanyard, magnetic charging cable

79,90

502250 Lamp Adapter Type C

1x Xtreme LED

Boost / Power / Mid Power / Low Power
(+ Position, Blink, S.O.S., Strobe)

1400 / 1000 / 440 / 15

300 / 210 / 130 / 15

- / 2 / 4 / 90

6000 - 7500

70

1x 21700 Li-ion Battery 3,7V

17,76 / 4800

IP68

Yes

270

2

158

35

202 / 7,1

•

•

•

•

•

Dimmable, Transportation Lock, Flicker-free, Memory Mode, Backup Mode, Emergency Light, Temperature Control System, Battery Indicator, Charge Indicator, Low Battery Warning

502181 / 4058205020510

1 battery set, lanyard, magnetic charging cable

99,90

502251 Lamp Adapter Type D

1x Xtreme LED

Boost / Power / Mid Power / Low Power
(+ Position, Blink, S.O.S., Strobe)

1200 / 900 / 350 / 15

560 / 420 / 270 / 50

- / 2,75 / 12 / 200

6000 - 7500

65

1x LiFePO4 Battery pack 6,4V

36,48 / 5700

IP54

Yes

270

1

290

53

715 / 25,2

•

•

•

•

•

Mode Switch, Dimmable, Transportation Lock, Flicker-free, Memory Mode, Backup Mode, Emergency Light, Safety Ytrion Cell, Rapid Focus, Battery Indicator, Charge Indicator, Low Battery Warning

502182 / 4058205020541

1 set of batteries, intelligent clip, wall bracket, power adapter, magnetic charging cable

199,00

0042 Signal Cone 53mm

^{1,2} Information on page 184

P6R CORE QC

NEW



1 MULTICOLOR LED
4 COLORS

- 01 – Equipped with a **Multicolor LED with white, red, green and blue light**
- 02 – **Multicolor Strobe** – colored flashes of light with irritating glare effect for emergencies
- 03 – **Easy Operation** – the rotary switch enables quick color changes
- 04 – **Advanced Focus System** – stepless focusing



P6R CORE QC



LED	
△ LED-Configuration	1x Power LED
▮ Light Functions (white light)	Power / Mid Power / Low Power
☀ Luminous flux ¹ (lm)	270 / 120 / 15
↔ Beam Distance ¹ (m)	335 / 220 / 80
🕒 Run Time ¹ (h)	5 / 14 / 110
🌡 Color temperature (K)	6000 - 7500
Ⓜ Color rendering index (CRI)	80 (White light)
BATTERY AND CASE	
🔋 Battery	1x Li-ion Battery pack 3,7V
🔋 Battery Capacity ² (Wh / mAh)	9,25 / 2500
☁ IP Level	IP54
🔌 Rechargeable	Yes
🕒 Charging Time ³ (min)	200
↓ Drop height (m)	1,5
SIZE AND WEIGHT	
↗ Length – defocused (mm)	157
⊙ Head diameter (mm)	42
⚖ Weight incl. Battery (g / oz)	207 / 7,3
TECHNOLOGY	
🔌 Dual Power Source	●
🎯 Rapid Focus	●
🔄 Advanced Focus System	●
More features	Multicolor Strobe, Single Color Strobe
PACKAGING	
Item no. Box / GTIN	502517 / 4058205026819
Contents Box	1 battery set, lanyard, USB charging cable
Price (MSRP) in €	69,90
OPTIONAL ACCESSORIES	
more accessories on page 61	502251 Lamp Adapter Type D

^{1,2} Information on page 184

SEEING THE WORLD IN A DIFFERENT LIGHT

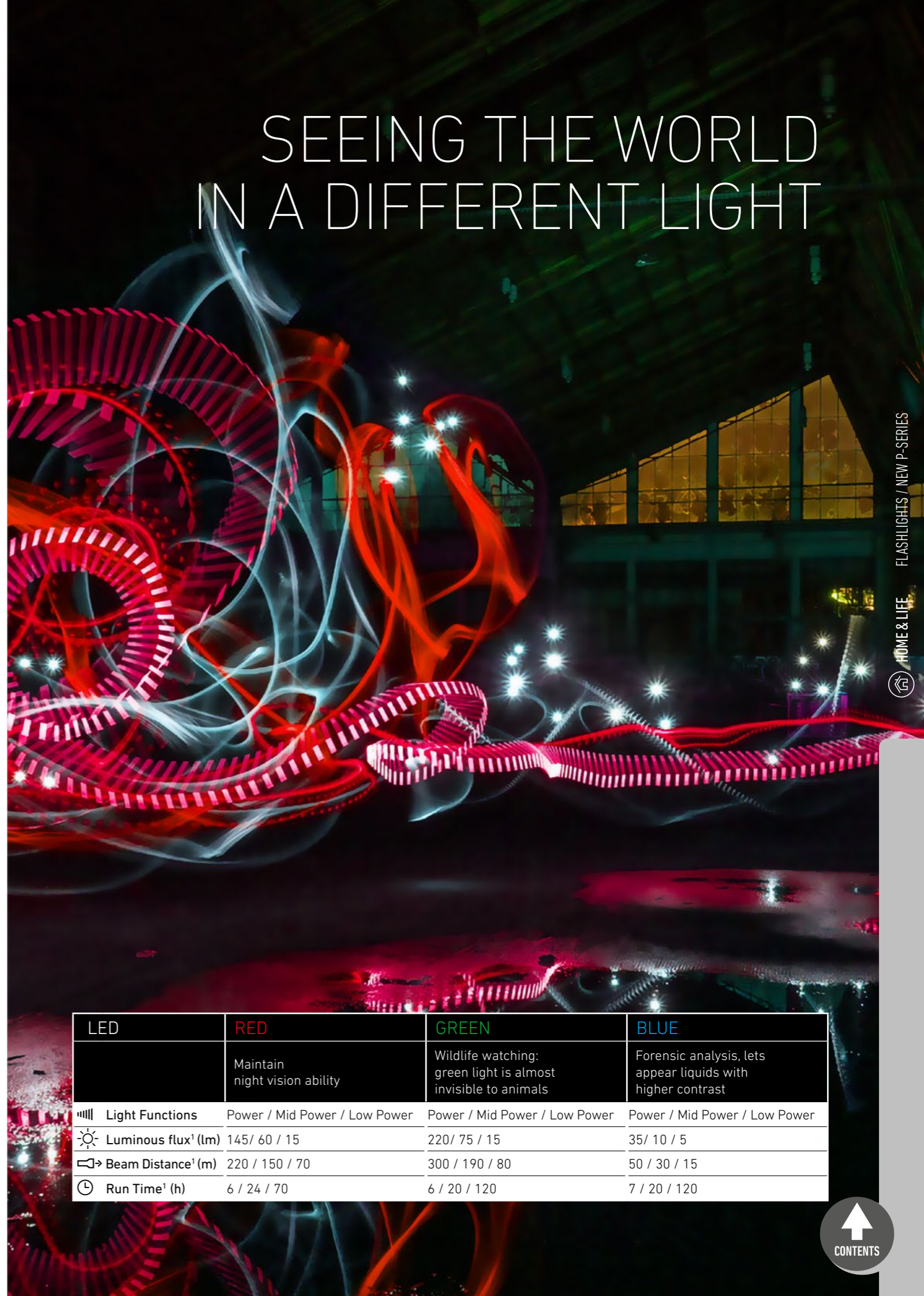

LED	RED	GREEN	BLUE
	Maintain night vision ability	Wildlife watching: green light is almost invisible to animals	Forensic analysis, lets appear liquids with higher contrast
▮ Light Functions	Power / Mid Power / Low Power	Power / Mid Power / Low Power	Power / Mid Power / Low Power
☀ Luminous flux ¹ (lm)	145/ 60 / 15	220/ 75 / 15	35/ 10 / 5
↔ Beam Distance ¹ (m)	220 / 150 / 70	300 / 190 / 80	50 / 30 / 15
🕒 Run Time ¹ (h)	6 / 24 / 70	6 / 20 / 120	7 / 20 / 120

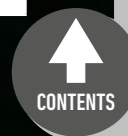

ACCESSORIES

FLASHLIGHTS

P-SERIES CORE



LEDLENSER CONNECTING SYSTEM

MODEL	P2R CORE	P4R CORE	P5R CORE	P6R CORE	P7R CORE	P6R CORE QC	Item no.	MSRP (€)
Lamp Adapter Type A NEW	•	•					502248	4,90
Lamp Adapter Type B NEW			•				502249	4,90
Lamp Adapter Type C NEW				•			502250	4,90
Lamp Adapter Type D NEW					•	•	502251	4,90
Tripod Adapter Type D NEW	•	•	•	•	•	•	502247	9,90
GoPro Adapter Type D NEW	•	•	•	•	•	•	502246	7,90
Belt Clip Type A NEW	•	•	•	•	•	•	502253	6,90
Helmet Mount for Euroslot Type A NEW	•	•	•	•	•	•	502254	6,90
Flexible Mount Type A NEW	•	•	•	•	•	•	502255	14,90
Universal Mounting Bracket Type E NEW	•	•	•	•	•	•	502256	12,90

Lamp Adapter Type A-D

Mounting adapter (Requirement)

The adapter enables the connection between flashlights and the versatile **LEDLENSER connecting system**. Now the light is compatible with various additional accessory brackets and mounts.



Multiple sizes / item no's.
4,90 € (MSRP)



Item no. 502246
GoPro Adapter
Compatible with almost all GoPro systems and accessories
7,90 € (MSRP)



Item no. 502255
Flexible Mount
Flexible fastening system with magnet, adhesive pad and hole to screw on
14,90 € (MSRP)



Item no. 502254
Helmet Mount for Euroslot
Hard hat mount for 30 mm Euroslot 6,90 € (MSRP)



Item no. 502256
Universal Mounting Bracket
Stable universal fastening to cylindrical objects 12,90 € (MSRP)



Item no. 502247
Tripod Adapter
Tripod adapter 9,90 € (MSRP)



Item no. 502253
Belt Clip Type A
Belt clip for lights and battery packs 6,90 € (MSRP)



Item no. 502126
Powerbank Flex3
More information on page 40
34,90 € (MSRP)



Item no. 502125
Powerbank Flex7
More information on page 40
54,90 € (MSRP)



Item no. 502128
Batterybox7
More information on page 40
29,90 € (MSRP)



Multiple sizes / item no's.
Charging Station
professional charging station
Includes magnetic charging cable, compatible with 5 Station Charging Panel
12,90 € (MSRP)



Multiple sizes / item no's.
Wall Mount
Wall mounting system
incl. magnetic charging cable
9,90 € (MSRP)



ACCESSORIES POWER SUPPLY

MODEL	P2R CORE	P4R CORE	P5R CORE	P6R CORE	P7 CORE	P7R CORE	P17R CORE	P6R CORE QC	Item no.	MSRP (€)
Powerbank Flex3 NEW				•				•	502126	34,90
Powerbank Flex7 NEW				•				•	502125	54,90
Batterybox7 NEW				•				•	502128	29,90
Magnetic Charging Cable Type A NEW	•	•	•	•		•			502265	6,90
Wall Mount Type A NEW (includes magnetic charging cable)				•					502257	9,90
Wall Mount Type B NEW (includes magnetic charging cable)						•			502258	9,90
Charging Station Type A NEW (includes magnetic charging cable)			•						502259	12,90
Charging Station Type B NEW (includes magnetic charging cable)				•		•			502260	12,90
5 Station Charging Panel NEW			•	•		•			502261	69,90
USB Adapter 2.4A NEW	•	•	•	•		•	•	•	502271	14,90
USB Power Supply and Adapter Cable	•	•						•	0389	14,90
Car Charger	•	•	•	•		•	•	•	0380	9,90
21700 Li-ion rechargeable battery 4800mAh NEW						•			502262	24,90
14500 Li-ion rechargeable battery 750 mAh			•						500985	12,90
18650 Li-ion rechargeable battery 3000 mAh				•				•	501001	24,90
4x AAA Alkaline Ionic					•				500981	3,49



ACCESSORIES

FLASHLIGHTS

P-SERIES CORE



Multiple sizes / item no's.
Signal Cone Red
 The plastic plug-in attachment transforms a Ledlenser flashlight into a versatile, red signal light, e.g. for use in road, rail and air traffic, emergencies or photography.
from 6,90 € (MSRP)



Multiple sizes / item no's.
Signal Cone White
 The plastic plug-in attachment transforms a Ledlenser flashlight into a versatile, white signal light. The flashlight with the white signal cone can also be converted into an area light, for example to evenly illuminate rooms or a tent.
from 6,90 € (MSRP)



Item no. 502263
Case Type A
Soft case transport bag: Inside there are elastic loops and a mesh pocket to attach the lamp, Powerbank, cables and other accessories. On the outside, a handle and loops for attachment to a belt or backpack ensure optimal portability. (Size 200mm x 135mm x 72mm)
24,90 € (MSRP)



Multiple sizes / item no's.
Color Filter Sets
 Color filter set: The filters are each pre-assembled on a color filter cap that can be attached directly to the lamp head of the compatible flashlight.
12,90 € (MSRP)



Item no. 502264
Case Type B
 With this high-quality, **fabric-covered hard case**, the Ledlenser lamp and accessories are always safely stored and protected from dust and external influences. Inside there are elastic loops and a mesh pocket to stow the lamp, Powerbank and other accessories. (Size 200mm x 135mm x 72mm)
29,90 € (MSRP)



Item no. 502269
Leather Pouch
 High quality belt bag made of real leather with magnetic closure
19,90 € (MSRP)



Item no. 0342
Pouch
 Fanny pack made of robust Polyamide fabric with elastic sidewalls
9,90 € (MSRP)

POUCHES / FILTERS / MOUNTS AND MORE

MODEL	P2R CORE	P4R CORE	P5R CORE	P6R CORE	P7 CORE	P7R CORE	P17R CORE	P6R CORE QC	Item no.	MSRP (€)
Color Filter Set 35.1mm NEW				•		•			502238	19,90
Color Filter Set 29.5mm NEW			•						502239	18,90
Color Filter Set 53mm NEW							•		502240	24,90
Color Filter Set 37mm					•				100879	19,90
Signal Cone 35.1mm NEW				•		•			502237	9,90
Signal Cone White 35.1mm NEW				•		•			502243	9,90
Signal Cone White 53mm NEW							•		502245	9,90
Signal Cone 37mm					•				0040	6,90
Signal Cone White 37mm					•				0040-W	6,90
Signal Cone 53mm							•		0042	9,90
Roll Protection 53mm NEW							•		502241	14,90
Roll Protection Ring					•				0320	6,90
Case Type A NEW						•			502263	24,90
Case Type B NEW						•			502264	29,90
Leather Pouch Type D				•		•			502269	19,90
Pouch Type D	•								0337	9,90
Pouch Type G				•		•		•	0342	9,90
Pouch Type A					•				0333	9,90
Pouch Type L			•						0340	7,90
Universal Mounting Bracket Type B			•	•	•	•		•	7799-PT	15,90
Intelligent Clip Type C					•				0317	8,90
Universal Mounting System				•	•	•		•	0362	14,90



Item no. 0362
Universal Mounting System
 This universal mounting system quickly attaches flashlights with a diameter of 25-34 mm securely to tripods, rods and tubes.
14,90 € (MSRP)



Item no. 0317
Intelligent Clip
 Belt clip: the holder can be rotated 360° and transforms the lamp into a flexible headlight
8,90 € (MSRP)



K-SERIES



K1

K2

LED		
LED-Configuration	1x Low Power LED	1x Power LED
Light Functions	Power	Power
Luminous flux ¹ (lm)	13	20
Beam Distance ¹ (m)	16	20
Run Time ¹ (h)	0,25	4
BATTERY AND CASE		
Battery	4x Button Cell (LR41) Alkaline 1,5V	4x Button Cell (LR44) Alkaline 1,5V
Battery Capacity ² (Wh / mAh)	-	-
Rechargeable	No	No
Charging Time ⁵ (min)	-	-
IP Level	IP54	IP54
SIZE AND WEIGHT		
Length – defocused (mm)	43	52
Head diameter (mm)	10,5	14,5
Weight incl. Battery (g / oz)	10 / 0,4	20 / 0,7
TECHNOLOGY		
Rapid Focus		
Advanced Focus System		
More features		
PACKAGING		
Item no. Box / GTIN	8201 / 4029113820103	8202 / 4029113820202
Item no. Blister / GTIN	8251 / 4029113825153	8252 / 4029113825252
Contents Box	1 set of batteries, key ring	1 set of batteries, key ring
Price (MSRP) in €	7,90	8,90

MINI FLASHLIGHTS WITH A KEY MOMENT



K3

K4R

LED		
LED-Configuration	1x Low Power LED	1x COB LED
Light Functions	Power	Power, S.O.S.
Luminous flux ¹ (lm)	14	60
Beam Distance ¹ (m)	33	10
Run Time ¹ (h)	1,3	1,5
BATTERY AND CASE		
Battery	4x Button Cell (LR44) Alkaline 1,5V	1x Li-ion Battery 3,7V (intern)
Battery Capacity ² (Wh / mAh)	-	0,67 / 180
Rechargeable	No	Yes
Charging Time ⁵ (min)	-	120
IP Level	IP54	IP2X
SIZE AND WEIGHT		
Length – defocused (mm)	77	50
Head diameter (mm)	20	22
Weight incl. Battery (g / oz)	29 / 1	17 / 0,6
TECHNOLOGY		
Rapid Focus	●	
Advanced Focus System	●	
More features		Charge Indicator, S.O.S.
PACKAGING		
Item no. Box / GTIN	8313 / 4029113831307	502066 / 4058205017343
Item no. Blister / GTIN	8613 (Test-it) / 4029113861359	502132 / 4058205019194
Contents Box	1 set of batteries, key ring	1 carabiner, USB cable
Price (MSRP) in €	15,90	16,90

^{1,2} Information on page 184

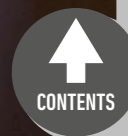

P-SERIES



P2

LED	
LED-Configuration	1x Low Power LED
Light Functions	Power
Luminous flux ¹ (lm)	16
Beam Distance ¹ (m)	25
Run Time ¹ (h)	7
BATTERY AND CASE	
Battery	1x Micro (AAA) Alkaline 1,5V
Battery Capacity ² (Wh / mAh)	-
Rechargeable	No
Charging Time ⁵ (min)	-
IP Level	IP54
SIZE AND WEIGHT	
Length – defocused (mm)	102
Head diameter (mm)	14,5
Weight incl. Battery (g / oz)	36 / 1,3
TECHNOLOGY	
Rapid Focus	
Advanced Focus System	●
More features	Energy Saving
PACKAGING	
Item no. Box / GTIN	8402 / 4029113840200
Item no. Blister / GTIN	8602 (Test-it) / 4029113860253
Contents Box	1 battery pack, belt pouch, lanyard, key ring, pocket clip
Price (MSRP) in €	14,90
OPTIONAL ACCESSORIES	
	500981 4x AAA Alkaline Ionic

LUMINOUS COMPANIONS WITH FAMILIAR QUALITY



P3



P4





P5

LED		LED		LED	
LED-Configuration	1x Power LED	LED-Configuration	1x Low Power LED	LED-Configuration	1x Power LED
Light Functions	Power	Light Functions	Power	Light Functions	Power
Luminous flux ¹ (lm)	25	Luminous flux ¹ (lm)	18	Luminous flux ¹ (lm)	140
Beam Distance ¹ (m)	60	Beam Distance ¹ (m)	25	Beam Distance ¹ (m)	120
Run Time ¹ (h)	6	Run Time ¹ (h)	8,5	Run Time ¹ (h)	4
BATTERY AND CASE		BATTERY AND CASE		BATTERY AND CASE	
Battery	1x Micro (AAA) Alkaline 1,5V	Battery	2x Micro (AAA) Alkaline 1,5V	Battery	1x Mignon (AA) Alkaline 1,5V
Battery Capacity ² (Wh / mAh)	-	Battery Capacity ² (Wh / mAh)	-	Battery Capacity ² (Wh / mAh)	-
Rechargeable	No	Rechargeable	No	Rechargeable	No
Charging Time ⁵ (min)	-	Charging Time ⁵ (min)	-	Charging Time ⁵ (min)	-
IP Level	IP54	IP Level	IP54	IP Level	IP54
SIZE AND WEIGHT		SIZE AND WEIGHT		SIZE AND WEIGHT	
Length – defocused (mm)	90	Length – defocused (mm)	147	Length – defocused (mm)	113
Head diameter (mm)	19	Head diameter (mm)	14,5	Head diameter (mm)	26
Weight incl. Battery (g / oz)	35 / 1,2	Weight incl. Battery (g / oz)	53 / 1,9	Weight incl. Battery (g / oz)	80 / 2,8
TECHNOLOGY		TECHNOLOGY		TECHNOLOGY	
Rapid Focus	●	Rapid Focus		Rapid Focus	●
Advanced Focus System	●	Advanced Focus System	●	Advanced Focus System	●
More features	Energy Saving	More features	Energy Saving	More features	Energy Saving
PACKAGING		PACKAGING		PACKAGING	
Item no. Box / GTIN	500882 / 4058205009393	Item no. Box / GTIN	8404 / 4029113840408	Item no. Box / GTIN	500895 / 4058205009850
Item no. Blister / GTIN	500883 (Test-it) / 4058205009423	Item no. Blister / GTIN	8604 (Test-it) / 4029113860451	Item no. Blister / GTIN	500896 (Test-it) / 4058205009867
Contents Box	1 battery pack, belt pouch, lanyard, key ring, pocket clip	Contents Box	1 battery pack, belt pouch, lanyard, key ring, pocket clip	Contents Box	1 battery pack, belt pouch, lanyard
Price (MSRP) in €	14,90	Price (MSRP) in €	24,90	Price (MSRP) in €	44,90
OPTIONAL ACCESSORIES		OPTIONAL ACCESSORIES		OPTIONAL ACCESSORIES	
	500981 4x AAA Alkaline Ionic		500981 4x AAA Alkaline Ionic		500980 4x AA Alkaline Ionic
					0315 Intelligent Clip Type A

^{1,2} Information on page 184

X21R



 5000 lm¹
 800 m¹
 40 h¹

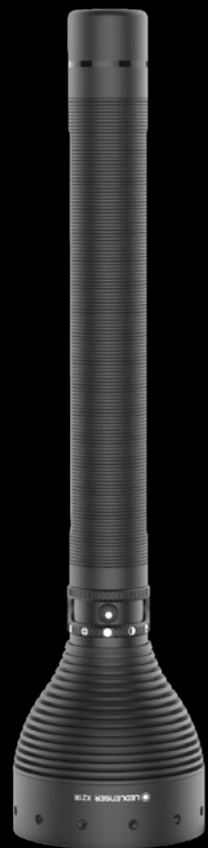





















- 01 – Extreme light output** – up to 800 meters¹ beam distance with up to 5000 lumens¹ thanks to seven Xtreme LEDs
- 02 – X-Lens Technology** – precise synchronization of the bundles of rays from several reflector lenses to form an extremely homogeneous, stage-like floodlight or a very sharply focused high beam
- 03 – Advanced Focus System** – stepless focusing
- 04** – High-quality battery system **Safety Ytrion Cell** - over 5000 charging cycles without significant loss of capacity
- 05** – Quick to hand - convenient charging with the **Floating Charge System**
- 06 – Great ease of use** – 7 light functions, 4 light programs, 2 energy modes, and 1 multi-function switch



THE ULTIMATE HAND-HELD SEARCHLIGHT

X21R

LED	
 LED-Configuration	7x Xtreme LED
 Light Functions	Boost / Power / Low Power (+ Blink, S.O.S., Strobe, Position)
 Luminous flux ¹ (lm)	5000 / 3500 / 200
 Beam Distance ¹ (m)	800 / 700 / 150
 Run Time ¹ (h)	- / 5 / 40
BATTERY AND CASE	
 Battery	1x LiFePO4 Battery pack 9,6V
 Battery Capacity ² (Wh / mAh)	48 / 5000
 Rechargeable	Yes
 Charging Time ⁵ (min)	210
 IP Level	IP54
SIZE AND WEIGHT	
 Length – defocused (mm)	405
 Head diameter (mm)	95
 Weight incl. Battery (g / oz)	1315 / 45,9
TECHNOLOGY	
 Smart Light Technology	●
 Rapid Focus	●
 Floating Charge System	●
 Advanced Focus System	●
 X-Lens Technology	●
 Emergency Light	●
 Safety Ytrion Cell	●
 Temperature Control	●
More features	Energy Saving, Constant Light, Charge Indicator, Battery Indicator, Dimmable, Transportation Lock
PACKAGING	
Item no. Case / GTIN	501967 / 4058205015394
Contents	1 battery set, floating charge system, assembly material, power supply unit, roll protection, tripod holder, carrying strap, case
Price (MSRP) in €	399,00
OPTIONAL ACCESSORIES	
more accessories on page 70	0386 Car Charger

¹⁻⁷ Information on page 184

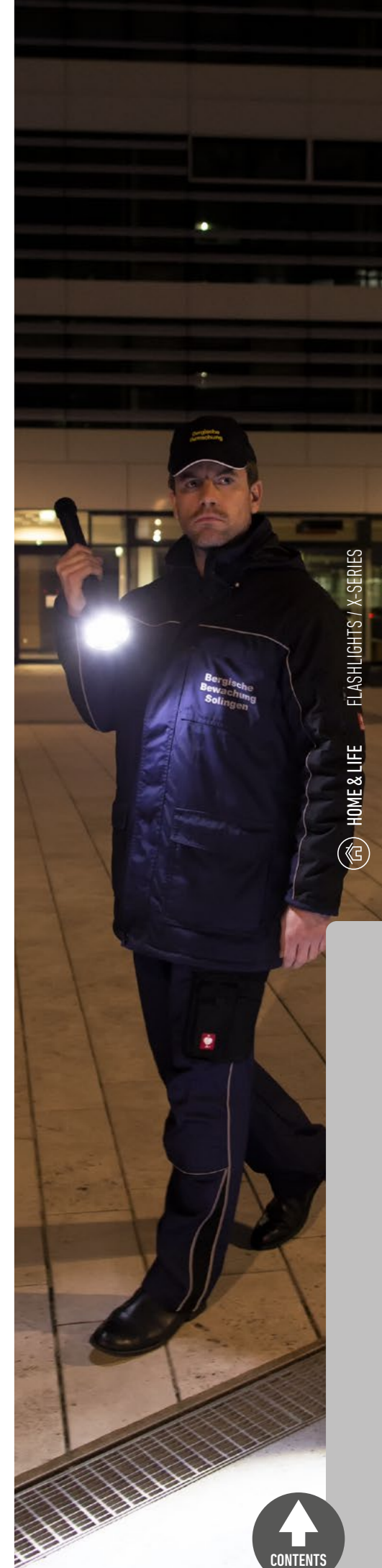

FLASHLIGHTS / X-SERIES

HOME & LIFE



ACCESSORIES

FLASHLIGHTS

POUCHES / HOLDERS AND MORE

MODEL	P2/3	P4	P5	X21R	Item no.	MSRP (€)
Pouch Type D			•		0337	9,90
Pouch Type L			•		0340	9,90
Intelligent Clip Type A			•		0315	8,90
Universal Mounting Bracket Type C			•		7799-PT5	12,90
Universal Mounting System			•		0362	14,90
Signal Cone 26 mm			•		7479	6,90
Car Charger				•	0386	19,90
4x AAA Alkaline Ionic	•	•			500981	3,49
4x AA Alkaline Ionic			•		500980	3,49



Item no. 7479
Signal Cone
Signal Cone
6,90 € (MSRP)



Item no. 0362
Universal Mounting System
This universal mounting fixes flashlights with a diameter of 25-34 mm securely to tripods, rods and tubes in next to no time. The lamp and fixation are aligned in parallel
14,90 € (MSRP)



Multiple sizes / item no's.
Pouch
Pouch
9,90 € (MSRP)



Item no. 0386
Car Charger
This handy 12-volt car charger with integrated cable fits into any cigarette lighter. So you can charge your Ledlenser on the go
19,90 € (MSRP)



Item no. 0317
Intelligent Clip
Practical belt clip: the holder can be rotated 360 ° and transforms the lamp into a flexible headlight
8,90 € (MSRP)



Item no. 7799-PT5
Universal Mounting Bracket Type C
With this universal attachment, flashlights can be easily attached to tripods, rods and tubes using a clamp screw. The flexible head of the bracket can be rotated 360 degrees
12,90 € (MSRP)



HOME & LIFE HEADLAMPS



 LEDLENSER



H7R CORE

THE NEW H-SERIES
ENLIGHTENMENT IS A
MATTER FOR THE HEAD

NEW



01 04



 1000 lm¹
 250 m¹
 65 h¹

- 01 – Intuitive operation and stepless dimming thanks to the **Wheel switch** on the lamp head
- 02 – Strong **dust and water protection (IP67)**
- 03 – Stepless **swivel mechanism** for vertical alignment of the light cone
- 04 – **Advanced Focus System** – stepless focusing
- 05 – Convenient and safe charging of the battery thanks to the **Magnetic Charge System**
- 06 – Integrated **battery and charge status display**
- 07 – **Ledlenser Connecting System** – an interface for many accessories (see page 78)

H-SERIES CORE

NEW



H5 CORE



H5R CORE



LED		
LED-Configuration	1x High Power LED	1x High Power LED
Light Functions	Boost / Power / Low Power	Boost / Power / Low Power
Luminous flux ¹ (lm)	350 / 200 / 15	500 / 300 / 15
Beam Distance ¹ (m)	160 / 120 / 30	200 / 150 / 30
Run Time ¹ (h)	- / 2 / 20	- / 2 / 50
Color temperature (K)	6000 - 7500	6000 - 7500
Color rendering index (CRI)	70	70
BATTERY AND CASE		
Battery	2x Mignon (AA) Alkaline 1,5V	1x Li-ion Battery pack 3,7V
Battery Capacity ² (Wh / mAh)	-	6,66 / 1800
IP Level	IP67	IP67
Rechargeable	No	Yes
Charging Time ⁵ (min)	-	210
Drop height (m)	1,5	1,5
SIZE AND WEIGHT		
Head diameter (mm)	32	32
Weight incl. Battery (g / oz)	178 / 6,3	167 / 5,9
TECHNOLOGY		
Multi-Core Optics		
Flex Sealing Technology	●	●
Magnetic Charge System		●
Fusion Beam		
Advanced Focus System	●	●
More features	Cooling Technology, Dimmable, Transportation Lock, Energy Saving	Cooling Technology, Temperature Control, Dimmable, Transportation Lock, Flicker-free, Memory Mode, Backup Mode, Battery Indicator, Charge Indicator, Low Battery Warning, Constant Light
PACKAGING		
Item no. Box / GTIN	502193 / 4058205020848	502121 / 4058205020879
Contents Box	1 set of batteries	1 set of batteries, magnetic charging cable
Price (MSRP) in €	49,90	69,90
OPTIONAL ACCESSORIES		
more accessories on page 78	502451 Transp. Silicone Headband NEW	502256 Universal Mounting Bracket NEW



H7R CORE



H15R CORE



H19R CORE



LED			
LED-Configuration	1x Xtreme LED	1x Xtreme LED	2x Xtreme LED
Light Functions	Boost / Power / Low Power	Boost / Power / Low Power	Boost / Power / Mid Power / Low Power
Luminous flux ¹ (lm)	1000 / 600 / 15	2500 / 1000 / 20	3500 / 1600 / 800 / 200
Beam Distance ¹ (m)	250 / 200 / 25	250 / 170 / 20	300 / 230 / 150 / 80
Run Time ¹ (h)	- / 4 / 65	- / 5 / 80	- / 4 / 7 / 20
Color temperature (K)	6000 - 7500	6000 - 7500	6000 - 7500
Color rendering index (CRI)	70	70	70
BATTERY AND CASE			
Battery	1x 21700 Li-ion Battery 3,7V	1x Li-ion Battery pack 7,4V	1x Li-ion Battery pack 7,4V
Battery Capacity ² (Wh / mAh)	17,76 / 4800	35,52 / 4800	35,52 / 4800
IP Level	IP67	IP67	IP68
Rechargeable	Yes	Yes	Yes
Charging Time ⁵ (min)	210	330	330
Drop height (m)	1,5	1,5	1,5
SIZE AND WEIGHT			
Head diameter (mm)	41	47	68
Weight incl. Battery (g / oz)	259 / 9,1	380 / 13,4	374 / 13,2
TECHNOLOGY			
Multi-Core Optics			
Flex Sealing Technology	●	●	●
Magnetic Charge System	●	●	●
Fusion Beam			●
Advanced Focus System	●	●	
More features	Cooling Technology, Temperature Control, Dimmable, Transportation Lock, Flicker-free, Memory Mode, Backup Mode, Battery Indicator, Charge Indicator, Low Battery Warning, Constant Light	Cooling Technology, Temperature Control, Dimmable, Transportation Lock, Flicker-free, Memory Mode, Backup Mode, Battery Indicator, Charge Indicator, Low Battery Warning, Constant Light	Temperature Control, Cooling Technology, , Optisense Technology, Dimmable, Transportation Lock, Flicker-free, Memory Mode, Backup Mode, Battery Indicator, Charge Indicator, Low Battery Warning, Constant Light, Red Light
PACKAGING			
Item no. Box / GTIN	502122 / 4058205020909	502123 / 4058205020930	502124 / 4058205020961
Contents Box	1 set of batteries, magnetic charging cable	1 set of batteries, magnetic charging cable	1 set of batteries, magnetic charging cable
Price (MSRP) in €	89,90	159,00	199,00
OPTIONAL ACCESSORIES			
502262 21700 Li-Ion Recharge. Battery NEW	502253 Belt Clip Type A NEW	502246 GoPro Adapter Type D NEW	



ACCESSORIES

HEADLAMPS

H-SERIES CORE

LEDLENSER CONNECTING SYSTEM

MODEL	H5 CORE	H5R CORE	H7R CORE	H15R CORE	H19R CORE	Item no.	MSRP (€)
GoPro Adapter Type D NEW	•	•	•	•	•	502246	7,90
Tripod Adapter Type D NEW	•	•	•	•	•	502247	9,90
Belt Clip Type A NEW	•	•	•	•	•	502253	6,90
Helmet Connecting Kit H NEW	•	•	•	•	•	502314	14,90
Universal Mounting Bracket Type E NEW	•	•	•	•	•	502256	12,90



Thanks to the integrated slide the lamp is immediately compatible with various additional brackets



Item no. 502246
GoPro Adapter
Compatible with almost all GoPro systems and accessories
7,90 € (MSRP)

Item no. 502247
Tripod Adapter
Tripod adapter
9,90 € (MSRP)

Item no. 502253
Belt Clip Type A
Practical belt clip for lights and batteries
6,90 € (MSRP)

Item no. 502314
Helmet Connecting Kit H
Stable helmet holder system for a wide variety of helmet models
14,90 € (MSRP)

Item no. 502256
Universal Mounting Bracket
Stable universal fastening for rods
12,90 € (MSRP)



NEW

Multiple sizes / item no's.
Color Filter Set
Four high quality color filters: Red maintains night vision. Green and red are among others suitable for wildlife viewing. Yellow improves visibility in fog. Blue improves the visibility of liquids
18,90 - 19,90 € (MSRP)



NEW

Item no. 502469
Headband with Overheadband CORE
Washable replacement headband with a removable overhead strap for additional support
9,90 € (MSRP)



NEW

Item no. 502313
Helmet Band Fixing Clips
Practical helmet attachment set - fixes every headlamp safely and precisely on the helmet
4,90 € (MSRP)



NEW

Item no. 502312
Extension Cable
Practical extension cable (120 cm) that is plugged in between the lamp head and the battery box - the battery can easily be stored in a backpack or carried on a belt clip
9,90 € (MSRP)

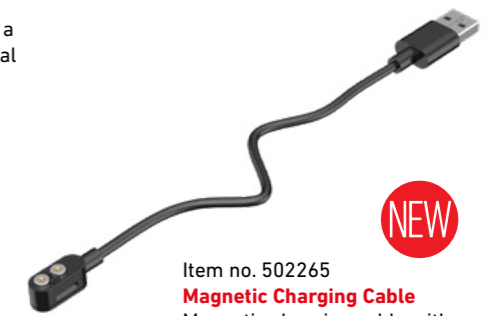

NEW

Item no. 502265
Magnetic Charging Cable
Magnetic charging cable with Standard USB-A connector
6,90 € (MSRP)

COLOR FILTERS / CABLES / BATTERIES AND MORE

MODEL	H5 CORE	H5R CORE	H7R CORE	H15R CORE	H19R CORE	Item no.	MSRP (€)
Color Filter Set 32mm NEW	•	•				502307	18,90
Color Filter Set 40mm NEW			•			502308	18,90
Color Filter Set 47mm NEW				•		502309	19,90
Headband with Overheadband CORE NEW	•	•	•	•	•	502469	9,90
Headband with Overheadband WORK NEW	•	•	•	•	•	502470	9,90
Headband with Overheadband SIGNATURE NEW	•	•	•	•	•	502471	12,90
Wireless Remote Control Type A NEW (can only be used in conjunction with Bluetooth® 2x 21700 Batterybox - 502411)				•		502311	34,90
Helmet Band Fixing Clips Type A NEW	•	•	•	•	•	502313	4,90
Transparent Silicone Headband Type A NEW	•	•	•	•	•	502451	9,90
Magnetic Charging Cable Type A NEW		•	•	•	•	502265	6,90
Extension Cable Type C NEW				•	•	502312	9,90
USB Adapter 2.4A NEW		•	•	•	•	502271	14,90
21700 Li-ion Rechargeable Battery 4800mAh NEW			•			502262	24,90
4x AA Alkaline Ionic	•					500980	3,49
2x 21700 Li-ion Rechargeable Battery Pack NEW				•	•	502310	39,90
Bluetooth® 2x 21700 Batterybox NEW				•	•	502411	59,90

H-SERIES

FREE HANDS,
PERFECT ILLUMINATION,
PROVEN QUALITY



H3.2

H4

LED	H3.2	H4
LED-Configuration	1x Power LED	1x Power LED
Light Functions	Power / Low Power	Boost / Power / Low Power
Luminous flux ¹ (lm)	120 / 5	250 / 150 / 20
Beam Distance ¹ (m)	100 / 20	35 / 25 / 10
Run Time ¹ (h)	6 / 60	- / 3 / 40
BATTERY AND CASE		
Battery	3x Micro (AAA) Alkaline 1,5V	3x Micro (AAA) Alkaline 1,5V
Battery Capacity ² (Wh / mAh)	-	-
Rechargeable	No	No
Charging Time ⁵ (min)	-	-
IP Level	IP54	IP57
SIZE AND WEIGHT		
Head diameter (mm)	28	70
Weight incl. Battery (g / oz)	133 / 4,7	100 / 3,53
TECHNOLOGY		
Wide Beam		●
Temperature Control		●
Advanced Focus System	●	
More features	Energy Saving, Dimmable	Constant Light, Low Battery Warning, Rear Light, Transportation Lock
PACKAGING		
Item no. Box / GTIN	500767 / 4058205000666	501096 / 4058205015561
Item no. Blister / GTIN	500768 (Test-it) / 4058205000673	501097 / 4058205015592
Contents Box	1 set of batteries	1 set of batteries
Price (MSRP) in €	29,90	29,90
OPTIONAL ACCESSORIES		
	0332 Pouch Type H	0332 Pouch Type H
	502313 Helmet Band Fixing Clips Type A	500981 4x AAA Alkaline Ionic
	0370 Overhead Headband Type A	502313 Helmet Band Fixing Clips Type A
	500981 4x AAA Alkaline Ionic	

more accessories on page 84

H4R



H4R

LED-Configuration	1x Power LED
Light Functions	Boost / Power / Low Power
Luminous flux ¹ (lm)	250 / 150 / 20
Beam Distance ¹ (m)	35 / 25 / 10
Run Time ¹ (h)	- / 3 / 40
BATTERY AND CASE	
Battery	1x LiPo Battery pack 3,7V
Battery Capacity ² (Wh / mAh)	5,18 / 1400
Rechargeable	Yes
Charging Time ⁵ (min)	240
IP Level	IP57
SIZE AND WEIGHT	
Head diameter (mm)	70
Weight incl. Battery (g / oz)	95 / 3,35
TECHNOLOGY	
Wide Beam	●
Temperature Control	●
Advanced Focus System	
More features	Constant Light, Low Battery Warning, Charge Indicator, Rear Light, Transportation Lock
PACKAGING	
Item no. Box / GTIN	501098 / 4058205015622
Item no. Blister / GTIN	501099 / 4058205015653
Contents Box	1 set of batteries, USB cable
Price (MSRP) in €	49,90
OPTIONAL ACCESSORIES	
	0332 Pouch Type H

¹⁻⁷ Information on page 184

 250 lm¹
 35 m¹
 40 h¹



- 01 – Wide Beam** – innovative optics and swiveling head for optimal illumination of the field of vision
- 02 – Li-ion-Battery** – conveniently via micro USB rechargeable
- 03 – Visible all around** thanks to the red flashing rear light
- 04 – High dust and water protection (IP57)**
- 05 – Backup Mode** – over one hour remaining – time from the first low battery warning



SEO-SERIES



SEO3

SEO5



SEO7R

LED		
LED-Configuration	1x Power LED	1x Power LED
Light Functions	Power / Low Power (+ Blink)	Power / Low Power (+ Blink)
Luminous flux ¹ (lm)	100 / 15	180 / 20
Beam Distance ¹ (m)	100 / 30	120 / 40
Run Time ¹ (h)	10 / 40	7 / 25
BATTERY AND CASE		
Battery	3x Micro (AAA) Alkaline 1,5V	3x Micro (AAA) Alkaline 1,5V
Battery Capacity ² (Wh / mAh)	-	-
Rechargeable	No	No
Charging Time ⁵ (min)	-	-
IP Level	IP56	IP56
SIZE AND WEIGHT		
Head diameter (mm)	29	29
Weight incl. Battery (g / oz)	105 / 3,7	105 / 3,7
TECHNOLOGY		
Rapid Focus	●	●
Temperature Control		●
Advanced Focus System	●	●
Smart Light Technology	●	●
Optisense Technology		
More features	Transportation Lock, Red Light, Dual Power Source	Low Battery Warning, Transportation Lock, Dimmable, Red Light, Dual Power Source
PACKAGING		
Item no. Box / GTIN	6003 (Green) / 4029113600309	6005 (Gray) / 4029113600507
Item no. Test-it-Blister / GTIN	6103 (Green) / 4029113610353	6105 (Gray) / 4029113610551
Item no. Box / GTIN	6004 (Orange) / 4029113600408	6006 (Red) / 4029113600606
Item no. Test-it-Blister / GTIN	6104 (Orange) / 4029113610452	6106 (Red) / 4029113610650
Contents Box	1 set of batteries	1 set of batteries
Price (MSRP) in €	24,90	39,90
OPTIONAL ACCESSORIES		
	7784 Li-ion Rech. Battery Pack 880 mAh	7784 Li-ion Rech. Battery Pack 880 mAh
	500981 4x AAA Alkaline Ionic	500981 4x AAA Alkaline Ionic
more accessories on page 84	0368 Helmet Connecting Kit	0368 Helmet Connecting Kit

LED	1x Power LED
Light Functions	Power / Low Power (+ Blink)
Luminous flux ¹ (lm)	220 / 20
Beam Distance ¹ (m)	130 / 40
Run Time ¹ (h)	5 / 20
BATTERY AND CASE	
Battery	1x Li-ion Battery pack 3,7V
Battery Capacity ² (Wh / mAh)	3,26 / 880
Rechargeable	Yes
Charging Time ⁵ (min)	240
IP Level	IP56
SIZE AND WEIGHT	
Head diameter (mm)	29
Weight incl. Battery (g / oz)	93 / 3,3
TECHNOLOGY	
Rapid Focus	●
Temperature Control	●
Advanced Focus System	●
Smart Light Technology	●
Optisense Technology	●
More features	Constant Light, Energy Saving, Charge Indicator, Low Battery Warning, Transportation Lock, Dimmable, Red Light, Dual Power Source
PACKAGING	
Item no. Box / GTIN	6007-R (Blue) / 4029113600705
Item no. Test-it-Blister / GTIN	6107-R (Blue) / 4029113610759
Item no. Box / GTIN	6007-RB (Black) / 4029113600736
Item no. Test-it-Blister / GTIN	6107-RB (Black) / 4029113610735
Contents Box	1 set of batteries, USB cable
Price (MSRP) in €	49,90
OPTIONAL ACCESSORIES	
	502313 Helmet Band Fixing Clips Type A
	7784 Li-ion Rech. Battery Pack 880 mAh
	0368 Helmet Connecting Kit

^{1,2} Information on page 184

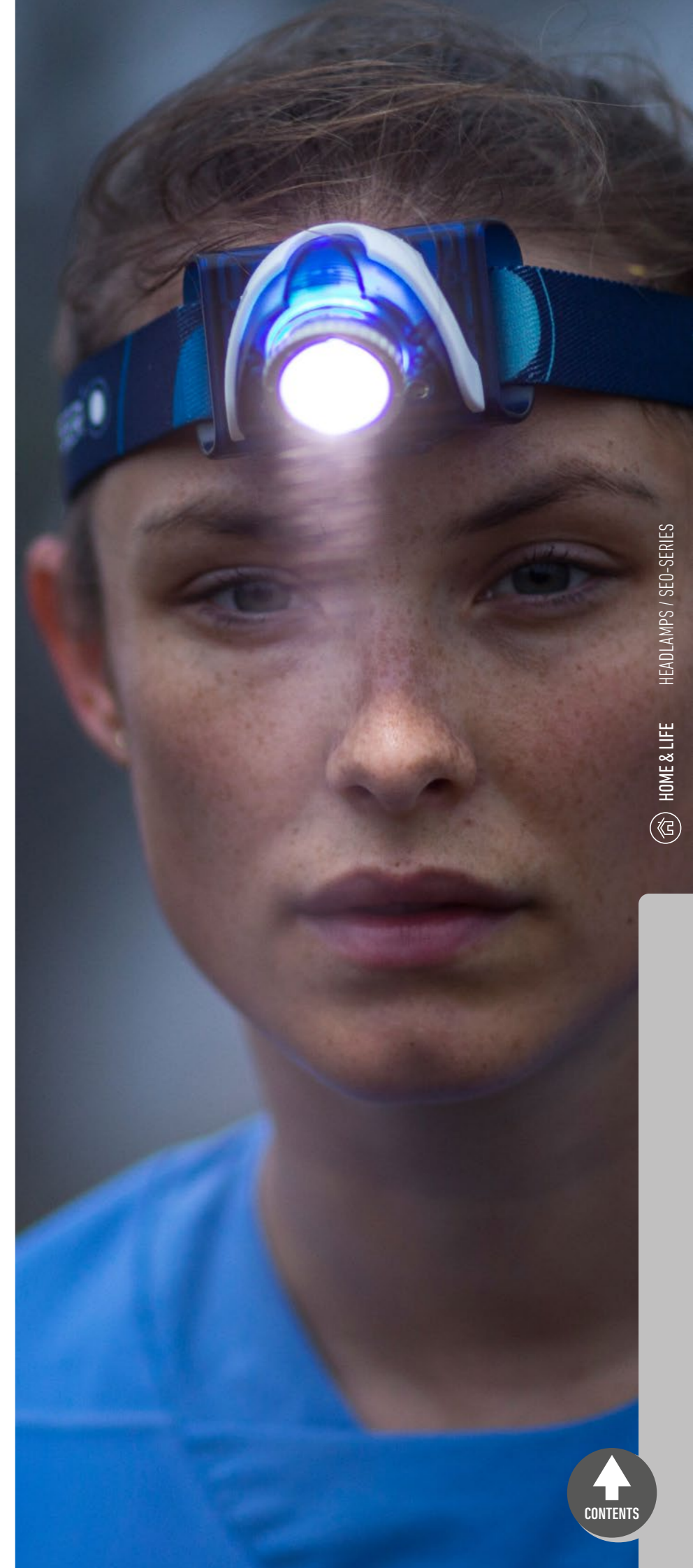

ACCESSORIES

HEADLAMPS

COLOR FILTERS / HOLDERS / BATTERIES AND MORE

MODEL	H3.2	H4/H4R	SE03	SE05	SE07R	Item no.	MSRP (€)
Helmet Band Fixing Clips Type A NEW	•	•	•	•	•	502313	4,90
Helmet Connecting Kit Type B			•	•	•	0368	9,90
Pouch Type H	•	•				0332	12,90
4x AAA Alkaline Ionic	•		•	•	•	500981	3,49
Li-ion Rechargeable Battery Pack 3,7V 880 mAh			•	•	•	7784	19,90
USB Car Charger					•	0380	9,90
USB Power Supply and Adapter Cable					•	0389	14,90



NEW

Item no. 502313
Helmet Band Fixing Clips
Practical helmet attachment set -
securely fixes every headlamp
and precisely on the helmet
4,90 € (MSRP)



Item no. 0368
Helmet Connecting Kit
Helmet attachment kit
for the SEO series
9,90 € (MSRP)



Item no. 0389
**USB Power Supply
and Adapter Cable**
USB charger with
adapter cable
14,90 € (MSRP)



Item no. 0380
USB Car Charger
USB car charger adapter - fits into
any conventional 12 volt
and 24 volt cigarette lighter
9,90 € (MSRP)

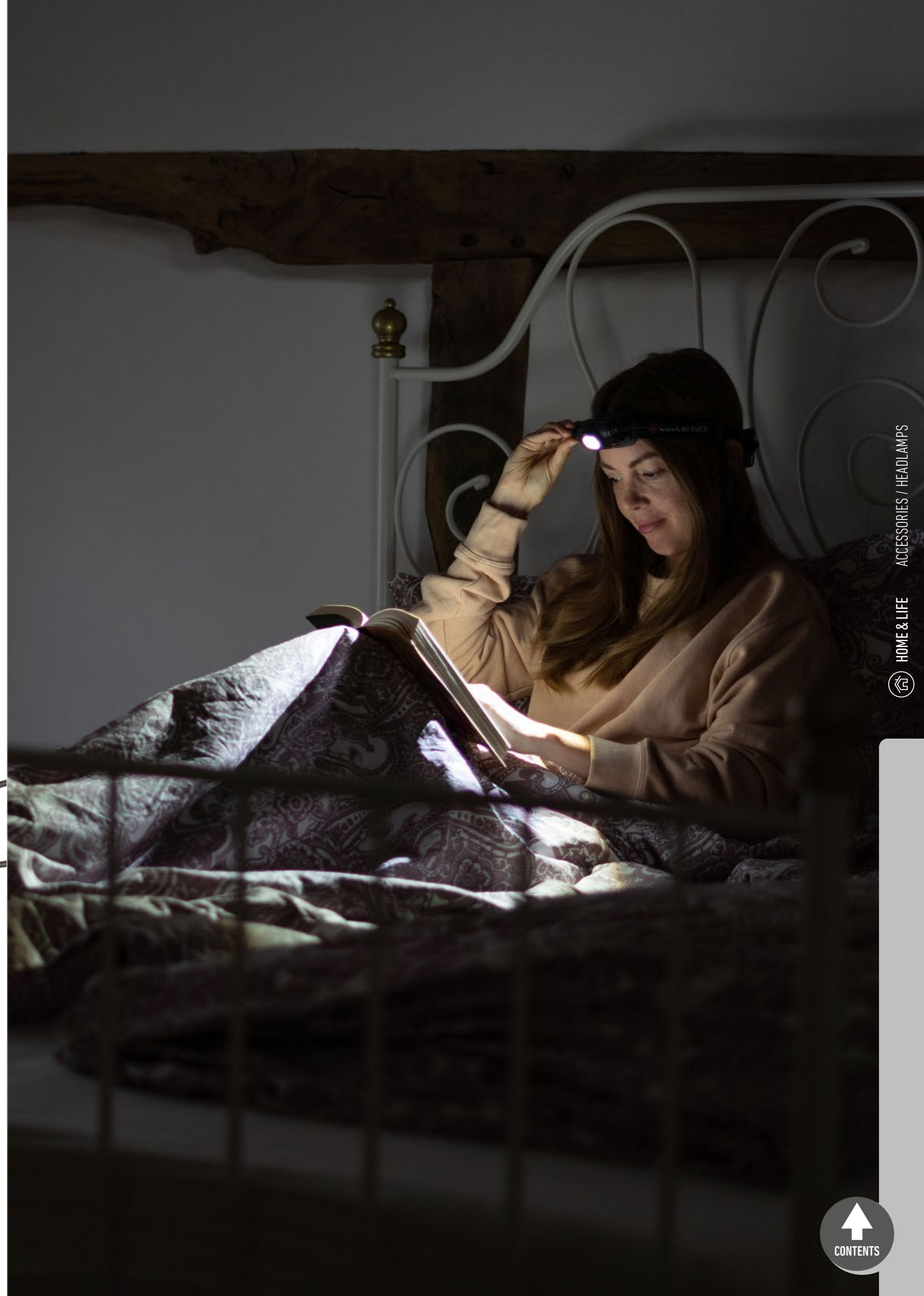

— WORK & PROFESSIONAL FLASHLIGHTS





 **LEDLENSER**

P7R WORK

NEW

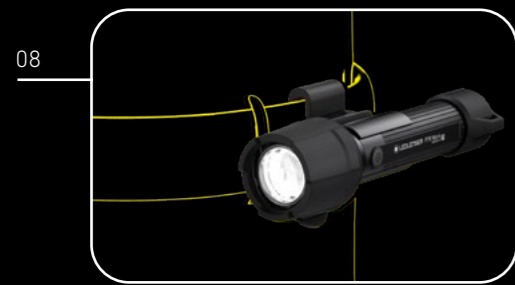
THE NEW P-SERIES INDESTRUCTIBLE LIGHT FOR PROFESSIONALS



 1200 lm¹
 240 m¹
 60 h¹

- 01** – Powerful work flashlight with **customizable light functions** and **natural color rendering (90 CRI / 4000K)**
- 02** – **Flicker-free** – Flicker-free, constant light enables strobe-free illumination, for fast-moving parts and machines
- 03** – **Protective elements on the lamp head and the end cap** absorb impacts and increase slip resistance; **the additional front lens cover** protects the lens from scratching
- 04** – Improved **chemical resistance** of the entire flashlight
- 05** – **Advanced Focus System** – stepless focusing
- 06** – Extreme **dust and water protection (IP68)**
- 07** – **White secondary light** on the side of the housing for diffuse illumination at close range
- 08** – **Ledlenser Connecting System** – one interface for many accessories (see page 32)
- 09** – **Robust charging station** - suitable for installation in a vehicle and compatible with the 5 station charging panel

^{1,7} Information on page 184

HANDY AND ROBUST LIGHTS



P2R WORK

P4R WORK

LED		
LED-Configuration	1x Power LED	1x Power LED
Light Functions	Power / Mid Power / Low Power	Power / Mid Power / Low Power
Luminous flux ¹ (lm)	110 / 50 / 15	170 / 70 / 15
Beam Distance ¹ (m)	90 / 60 / 20	100 / 65 / 20
Run Time ¹ (h)	0,5 / 1,5 / 7	1,25 / 3 / 15
Color temperature (K)	4200 - 4500	4200 - 4500
Color rendering index (CRI)	80	80
BATTERY AND CASE		
Battery	1x Li-ion Batterypack 3,7V	1x Li-ion Batterypack 3,7V
Battery Capacity ² (Wh / mAh)	1,8 / 320	2,77 / 750
IP Level	IP54	IP54
Rechargeable	Yes	Yes
Charging Time ⁵ (min)	150	150
Drop height (m)	2	2
SIZE AND WEIGHT		
Length – defocused (mm)	120	164
Head diameter (mm)	15	15
Weight incl. Battery (g / oz)	44 / 1,6	62 / 2,2
TECHNOLOGY		
Smart Light Technology		
Flex Sealing Technology		
Magnetic Charge System	●	●
Temperature Control		
Advanced Focus System	●	●
More features	Energy Saving, Charge Indicator	Energy Saving, Charge Indicator
PACKAGING		
Item no. Box / GTIN	502183 / 4058205020572	502184 / 4058205020602
Contents Box	1 battery set, belt pouch, lanyard, magnetic charging cable, pocket clip	1 battery set, belt pouch, lanyard, magnetic charging cable, pocket clip
Price (MSRP) in €	34,90	44,90
OPTIONAL ACCESSORIES		
more accessories on page 94	502248 Lamp Adapter Type A	502248 Lamp Adapter Type A



P5R WORK

LED	1x High Power LED
Light Functions	Boost / Power / Mid Power / Low Power (+ Position, Blink, S.O.S., Strobe)
Luminous flux ¹ (lm)	480 / 320 / 120 / 15
Beam Distance ¹ (m)	240 / 165 / 100 / 30
Run Time ¹ (h)	- / 1 / 3 / 25
Color temperature (K)	3700 - 4400
Color rendering index (CRI)	70
Battery	1x 14500 Li-ion Battery 3,7V
Battery Capacity ² (Wh / mAh)	2,77 / 750
IP Level	IP68
Rechargeable	Yes
Charging Time ⁵ (min)	120
Drop height (m)	3
Length – defocused (mm)	132
Head diameter (mm)	38
Weight incl. Battery (g / oz)	124 / 4,4
Smart Light Technology	●
Flex Sealing Technology	●
Magnetic Charge System	●
Temperature Control	●
Advanced Focus System	●
More features	Chemical Resistant, Dimmable, Transportation Lock, Flicker-free, Memory Mode, Backup Mode, Emergency Light, Battery Indicator, Charge Indicator, Low Battery Warning
Item no. Box / GTIN	502185 / 4058205020633
Contents Box	1 battery set, intelligent clip, charging station, belt pouch, lanyard, power adapter, magnetic charging cable
Price (MSRP) in €	69,90
Optional Accessories	502254 Helmet Mount for Euroslot

¹⁻⁷ Information on page 184

P-SERIES WORK

NEW



FLASHLIGHTS / NEW P-SERIES

WORK & PROFESSIONAL



HIGH-PERFORMANCE POWER PACKS

NEW



P6R WORK



P7R WORK



LED		
LED-Configuration	1x Xtreme LED, (1x Low Power LED)	1x Xtreme LED, (1x Low Power LED)
Light Functions	Boost / Power / Mid Power / Low Power (+ Position, Blink, S.O.S., Strobe)	Boost / Power / Mid Power / Low Power (+ Position, Blink, S.O.S., Strobe)
Luminous flux ¹ (lm)	850 / 700 / 300 / 15	1200 / 900 / 390 / 15
Beam Distance ¹ (m)	230 / 190 / 115 / 20	240 / 180 / 115 / 15
Run Time ¹ (h)	- / 1,5 / 2,5 / 45	- / 2 / 3,25 / 60
Color temperature (K)	3700 - 4400	3700 - 4400
Color rendering index (CRI)	90	90
BATTERY AND CASE		
Battery	1x 18650 Li-ion Battery 3,6V	1x 21700 Li-ion Battery 3,7V
Battery Capacity ² (Wh / mAh)	10,89 / 3000	17,76 / 4800
IP Level	IP68	IP68
Rechargeable	Yes	Yes
Charging Time ⁵ (min)	225	270
Drop height (m)	3	3
SIZE AND WEIGHT		
Length – defocused (mm)	163	170
Head diameter (mm)	45	45
Weight incl. Battery (g / oz)	187 / 6,6	219 / 7,7
TECHNOLOGY		
Smart Light Technology	●	●
Flex Sealing Technology	●	●
Natural Light	●	●
Multi-Core Optics	●	●
Advanced Focus System	●	●
More features	White Secondary Light, Magnetic Charge System, Temperature Control, Chemical Resistant, Dimmable, Transportation Lock, Flicker-free, Memory Mode, Backup Mode, Emergency Light, Battery Indicator, Charge Indicator, Low Battery Warning	White Secondary Light, Magnetic Charge System, Temperature Control, Chemical Resistant, Dimmable, Transportation Lock, Flicker-free, Memory Mode, Backup Mode, Emergency Light, Battery Indicator, Charge Indicator, Low Battery Warning
PACKAGING		
Item no. Box / GTIN	502186 / 4058205020664	502187 / 4058205020695
Contents Box	1 battery set, intelligent clip, charging station, belt pouch, lanyard, USB power adapter, magnetic charging cable	1 battery set, intelligent clip, charging station, belt pouch, lanyard, USB power adapter, magnetic charging cable
Price (MSRP) in €	99,90	129,00
OPTIONAL ACCESSORIES		
more accessories on page 94	502255 Flexible Mount Type A	500958 Signal Cone 42mm



P18R WORK



LED-Configuration	3x Xtreme LED
Light Functions	Boost / Power / Mid Power / Low Power (+ Position, Blink, S.O.S., Strobe)
Luminous flux ¹ (lm)	4500 / 2600 / 1000 / 30
Beam Distance ¹ (m)	720 / 420 / 260 / 50
Run Time ¹ (h)	- / 2,5 / 4,5 / 70
Color temperature (K)	4700 - 5500
Color rendering index (CRI)	70
BATTERY AND CASE	
Battery	1x Li-ion Battery pack 11,1V
Battery Capacity ² (Wh / mAh)	33,3 / 3000
IP Level	IP54
Rechargeable	Yes
Charging Time ⁵ (min)	330
Drop height (m)	1
SIZE AND WEIGHT	
Length – defocused (mm)	183
Head diameter (mm)	99
Weight incl. Battery (g / oz)	669 / 23,6
TECHNOLOGY	
Smart Light Technology	●
Flex Sealing Technology	●
Natural Light	●
Multi-Core Optics	●
Advanced Focus System	●
More features	X-Lens Technology, Magnetic Charge System, Rapid Focus, Dimmable, Transportation Lock, Flicker-free, Memory Mode, Backup Mode, Emergency Light, Battery Indicator, Charge Indicator, Low Battery Warning
PACKAGING	
Item no. Box / GTIN	502188 / 4058205020725
Contents Box	1 battery set, lanyard, USB power adapter, magnetic charging cable
Price (MSRP) in €	249,00
OPTIONAL ACCESSORIES	
more accessories on page 94	501508 Color Filter Red

P18R WORK



4500 lm¹
720 m¹
70 h¹

- 01 – X-Lens Technology** – precise synchronization of the beams from several reflector lenses to form an extremely homogeneous, stage-like floodlight or a very sharply bundled high beam
- 02 – Protective elements on the lamp head and the end cap** absorb impacts and increase slip resistance; **the additional front lens cover** protects the lens from scratching
- 03 – Flicker-free** – flicker-free, constant light enables optimal and safe illumination of fast-moving parts and machines
- 04** – Personalize the light functions thanks to the **Smart Light Technology**
- 05 – Advanced Focus System** – stepless focusing
- 06** – Convenient and safe charging of the battery thanks to the **Magnetic Charge System**

¹⁻⁷ Information on page 184



ACCESSORIES

FLASHLIGHTS

P-SERIES WORK

NEW

LEDLENSER CONNECTING SYSTEM

MODEL	P2R WORK	P4R WORK	P5R WORK	P6R WORK	P7R WORK	Item no.	MSRP (€)
Lamp Adapter Type A NEW	•	•				502248	4,90
Lamp Adapter Type B NEW			•			502249	4,90
Lamp Adapter Type C NEW				•		502250	4,90
Lamp Adapter Type D NEW					•	502251	4,90
GoPro Adapter Type D NEW	•	•	•	•	•	502246	7,90
Tripod Adapter Type D NEW	•	•	•	•	•	502247	9,90
Belt Clip Type A NEW	•	•	•	•	•	502253	6,90
Helmet Mount for Euroslot Type A NEW	•	•	•	•	•	502254	6,90
Flexible Mount Type A NEW	•	•	•	•	•	502255	14,90
Universal Mounting Bracket Type E NEW	•	•	•	•	•	502256	12,90

Lamp Adapter Type A-D

Mounting adapter (Requirement)
The adapter enables the connection between flashlights and the versatile **LEDlenser connecting system**. Now the light is compatible with various additional accessory brackets and mounts.

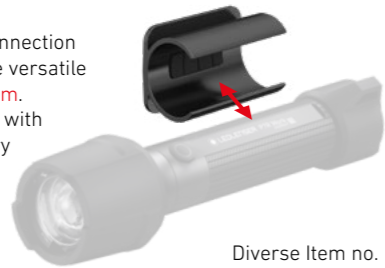

Diverse Item no. **4,90 € (MSRP)**



Item no. 502246 **GoPro Adapter**
Compatible with almost all GoPro systems and accessories **7,90 € (MSRP)**



Item no. 502255 **Flexible Mount**
Flexible fastening system with magnet, adhesive pad and hole to screw on **14,90 € (MSRP)**



Item no. 502254 **Helmet Mount for Euroslot**
Hard hat mount for 30 mm Euroslot **6,90 € (MSRP)**



Item no. 502256 **Universal Mounting Bracket**
Stable universal fastening for rods **12,90 € (MSRP)**



Item no. 502247 **Tripod Adapter**
Tripod adapter **9,90 € (MSRP)**



Item no. 502253 **Belt Clip Type A**
Belt clip for lights and batteries **6,90 € (MSRP)**

EVERYTHING ABOUT THE LEDLENSER CONNECTING SYSTEM ► S. 32

ACCESSORIES POWER SUPPLY



NEW

Multiple sizes / item no's.
Charging Station
professional charging station including magnetic charging cable, compatible with 5 station charging panel
12,90 € (MSRP)



NEW

Item no. 502125
Powerbank Flex7
More information on page 40
54,90 € (MSRP)



NEW

Item no. 0409
Mounting Plate
Mounting device (in Connection with charging station) with fastening loop for walls or in vehicles
5,90 € (MSRP)



NEW

Item no. 502261
5 Station Charging Panel
Charge up to five compatible Ledlenser Lamps (requirement: matching charging station)
69,90 € (MSRP)

MODEL	P2R WORK	P4R WORK	P5R WORK	P6R WORK	P7R WORK	P18R WORK	Item no.	MSRP (€)
Powerbank Flex3 NEW				•			502126	34,90
Powerbank Flex7 NEW				•			502125	54,90
Batterybox7 NEW				•			502128	29,90
Magnetic Charging Cable Type A NEW	•	•	•	•	•	•	502265	6,90
Wall Mount Type A NEW (including magnetic charging cable)				•			502257	9,90
Wall Mount Type B NEW (including magnetic charging cable)					•		502258	9,90
Charging Station Type A NEW (including magnetic charging cable)			•				502259	12,90
Charging Station Type B NEW (including magnetic charging cable)				•	•		502260	12,90
5 Station Charging Panel NEW			•	•	•		502261	69,90
USB Adapter 2.4A NEW	•	•	•	•	•	•	502271	14,90
USB Car Charger	•	•	•	•	•	•	0380	9,90
21700 Li-ion rechargeable battery 4800mAh NEW					•		502262	24,90
14500 Li-ion rechargeable battery 750 mAh			•				500985	12,90
18650 Li-ion rechargeable Battery 3000 mAh				•			501001	24,90
Mounting Plate			•	•	•		0409	5,90



ACCESSORIES

FLASHLIGHTS

P-SERIES WORK

POUCHES / FILTERS / MOUNTS AND MORE

MODEL	P2R WORK	P5R WORK	P6R WORK	P7R WORK	P18R WORK	Item no.	MSRP (€)
Color Filter Blue 85.5mm					•	501507	24,90
Color Filter Red 85.5mm					•	501508	24,90
Color Filter Green 85.5mm					•	501509	24,90
Color Filter Yellow 85.5mm					•	501510	24,90
Signal Cone 42mm			•	•		500958	6,90
Signal Cone White 42mm			•	•		502244	9,90
Roll Protection 85,5mm					•	502242	14,90
Case Type A NEW			•	•		502263	24,90
Case Type B NEW			•	•		502264	29,90
Pouch Type O			•	•		502268	9,90
Pouch Type D	•					0337	9,90
Pouch Type A		•				0333	9,90
Universal Mounting Bracket Type B		•	•	•		7799-PT	15,90
Universal Mounting System			•	•		0362	14,90



Item no. 501507
Color Filter Blue
Color filter with roll protection. Blue improves e.g. the visibility of traces and liquids
24,90 € (MSRP)



Item no. 501508
Color Filter Red
Color filter with roll protection. Red reduces e.g. reflections and maintains night vision
24,90 € (MSRP)



Item no. 501509
Color Filter Green
Color filter with roll protection. Green is suitable, among other things for wildlife viewing
24,90 € (MSRP)



Item no. 501510
Color Filter Yellow
Color filter with roll protection. Yellow improves i.e. the visibility in fog
24,90 € (MSRP)



NEW

Item no.502263

Case Type A

Soft case transport bag: Inside there are elastic loops and a mesh pocket to attach the light, Powerbank, cables and other accessories. On the outside, a handle and loops for attachment to a belt or backpack ensure optimal portability. (Size 200mm x 135mm x 72mm)
24,90 € (MSRP)



NEW

Item no.502264

Case Type B

With this high-quality, **fabric-covered hard case**, the Ledlenser lamp and accessories are always safely stored and protected from dust and external influences. Inside there are elastic loops and a mesh pocket to stow the lamp, Powerbank and other accessories. (Size 200mm x 135mm x 72mm)
29,90 € (MSRP)



Item no.0362

Universal Mounting System

This universal mounting fixes flashlights with a diameter of 25-34 mm securely to tripods, rods and tubes in next to no time. The lamp and fixation are aligned in parallel.
14,90 € (MSRP)



Item no.7799-PT

Universal Mounting Bracket

With this stable universal mount, rod and headlamps can be attached to tripods or poles. A stable rubber ring is used for fixation included.
15,90 € (MSRP)

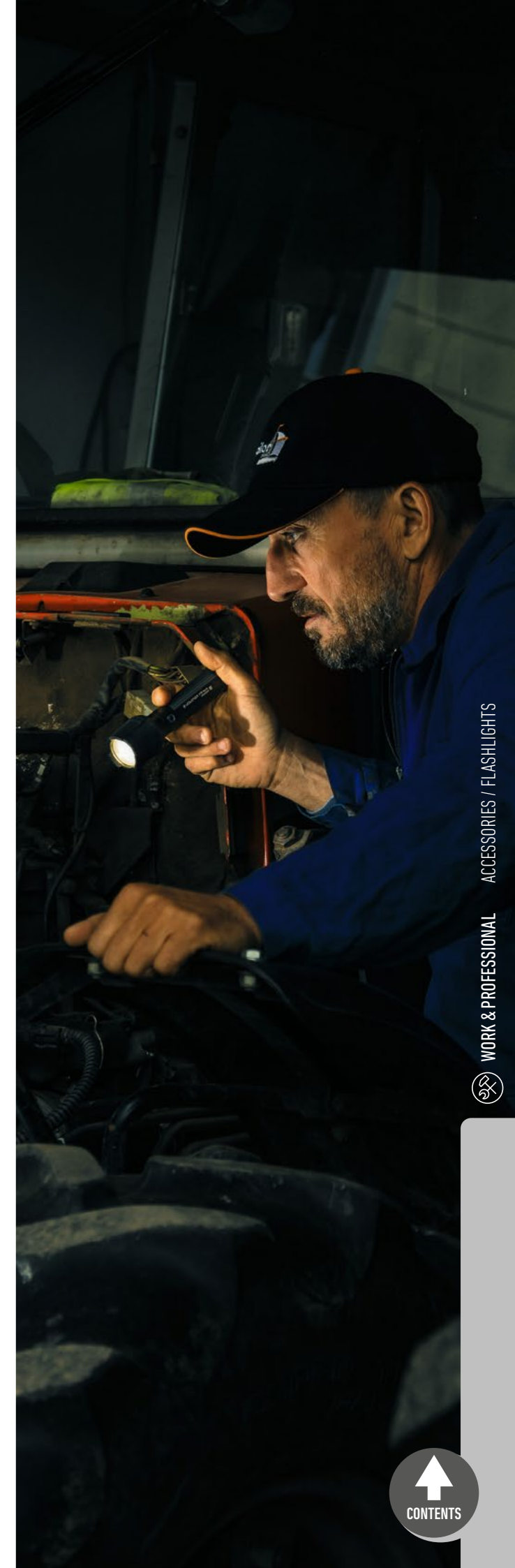

i-SERIES



i4

iL4

LED		
LED-Configuration	1x Power LED	1x Power LED
Light Functions	Power / Low Power	Power
Luminous flux ¹ (lm)	120 / 10	80
Beam Distance ¹ (m)	80 / 20	50
Run Time ¹ (h)	4 / 20	4
BATTERY AND CASE		
Battery	2x Micro (AAA) Alkaline 1,5V	2x Micro (AAA) Alkaline 1,5V
Battery Capacity ² (Wh / mAh)	-	-
Rechargeable	No	No
Charging Time ⁵ (min)	-	-
IP Level	IP54	IP66 and IP68
SIZE AND WEIGHT		
Head diameter (mm)	15	20
Length (mm)	140	140
Weight incl. Battery (g / oz)	55 / 1,9	65 / 2,3
TECHNOLOGY		
Advanced Focus System	●	-
More features	Energy Saving	-
CERTIFICATION		
EX-Zone	-	2/22
Gas and dust groups	-	IIC / IIIC
Temperature class	-	T4/T135°C
PACKAGING		
Item no. Sleeve Box / GTIN	500753 / 4058205000635	500684 / 4058205000444
Contents Box	1 set of batteries, pocket clip	1 set of batteries
Price (MSRP) in €	34,90	34,90
OPTIONAL ACCESSORIES		
	500981 4x AAA Alkaline Ionic	500954 Helmet Mount Type A
		500955 Helmet Mount Type B
		500956 Intelligent Clip Type F
		500981 4x AAA Alkaline Ionic

more accessories on page 100



iL7

iL7R

LED		
LED-Configuration	1x Xtreme LED	1x Xtreme LED
Light Functions	Power / Low Power	Power / Low Power
Luminous flux ¹ (lm)	340 / 70	360 / 55
Beam Distance ¹ (m)	165 / 80	170 / 70
Run Time ¹ (h)	7 / 37	6 / 40
BATTERY AND CASE		
Battery	3x Mignon (AA) Alkaline 1,5V	1x Li-ion Batterypack 3,7V
Battery Capacity ² (Wh / mAh)	-	12 / 3250
Rechargeable	No	Yes
Charging Time ⁵ (min)	-	570
IP Level	IP66 and IP68	IP66 and IP68
SIZE AND WEIGHT		
Head diameter (mm)	41	41
Length (mm)	161	161
Weight incl. Battery (g / oz)	232 / 8,2	228 / 8,0
TECHNOLOGY		
Advanced Focus System	●	●
More features	-	Charge Indicator
CERTIFICATION		
EX-Zone	2/22	2/22
Gas and dust groups	IIC / IIIC	IIC / IIIC
Temperature class	T4/T135°C	T4/T135°C
PACKAGING		
Item no. Sleeve Box / GTIN	500838 / 4058205001304	501052 / 4058205008624
Contents Box	1 set of batteries, pocket clip	1 set of batteries, pocket clip, charging station, power supply
Price (MSRP) in €	69,90	139,90
OPTIONAL ACCESSORIES		
	500957 Intelligent Clip Type G	500957 Intelligent Clip Type G
	500958 Signal Cone 42mm	500958 Signal Cone 42mm
	500980 4x AA Alkaline Ionic	502261 5 Station Charging Panel
		0386 Car Charger

¹⁻⁷ Information on page 184

iL7R



ADVANCED FOCUS SYSTEM

- 01 – Magnetic Switch** for easy operation even with gloves
- 02 – Advanced Focus System** – stepless focusing
- 03 – Extreme dust and water protection (IP66 and IP68)**
- 04 – Comfortable to be charged** using the charging cradle

ACCESSORIES

FLASHLIGHTS

HALTERUNGEN / BATTERYS AND MORE

MODEL	i4	iL4	iL7	iL7R	Item no.	MSRP (€)
Signal Cone Orange 42 mm			•	•	500958	6,90
Car Charger				•	0386	19,90
5 Station Charging Panel				•	502261	69,90
Helmet Mount Type A		•			500954	19,90
Helmet Mount Type B		•			500955	19,90
Intelligent Clip Type F		•			500956	8,90
Intelligent Clip Type G			•	•	500957	8,90
4x AA Alkaline Ionic			•		500980	3,49
4x AAA Alkaline Ionic	•	•			500981	3,49



Item no. 500954
Helmet Mount Type A
The bracket fits most helmet models (max. 12 mm thick). The light beam can be flexibly aligned with the ball joint
19,90 € (MSRP)



Item no. 500955
Helmet Mount Type B
Bracket with the same concept as the Helmet Mount Type A, in which the light moves a little further up.
19,90 € (MSRP)



Item no. 500957
Intelligent Clip Type G
Belt clip for iL7 and iL7R with ball joint, can be aligned as required
8,90 € (MSRP)



Item no. 500956
Intelligent Clip Type F
Belt clip for iL4 with ball joint, can be aligned as required
8,90 € (MSRP)



Item no. 500953
Signal Cone
Your safety comes first: this plug-in unit transforms the Ledlenser flashlight into a versatile signal light
6,90 € (MSRP)



Item no. 502261
5 Station Charging Panel
Allows simultaneous charge up to five iL7Rs
69,90 € (MSRP)

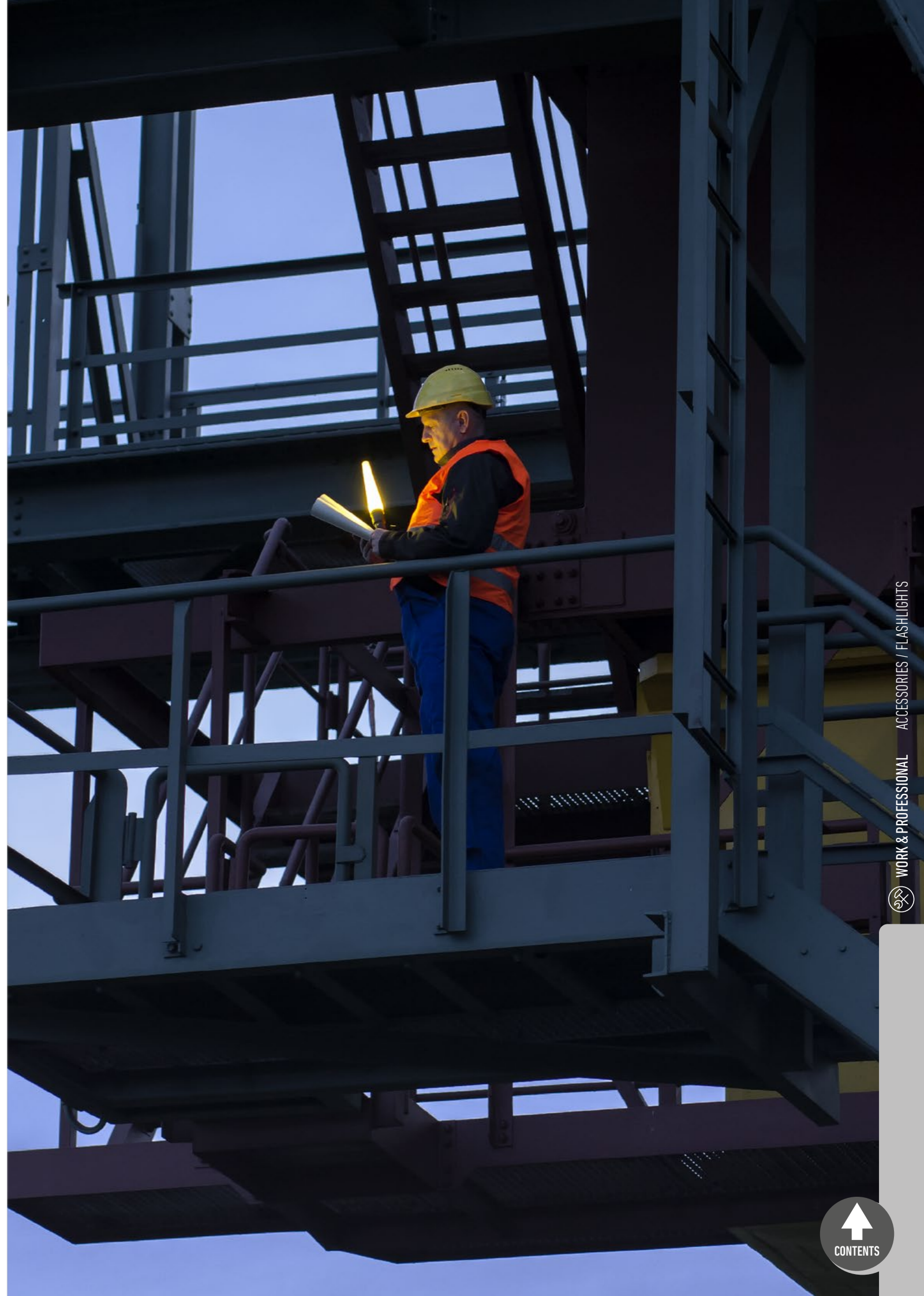

WORK & PROFESSIONAL HEADLAMPS



 LEDLENSER

H15R WORK

THE NEW H-SERIES THE WORKHORSE AMONG THE HEADLAMPS

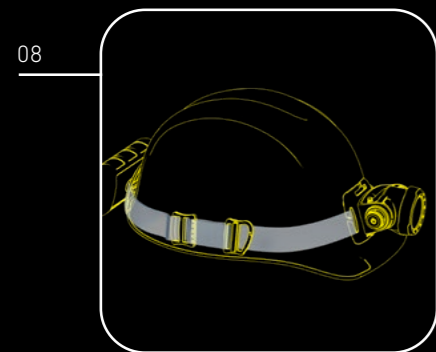
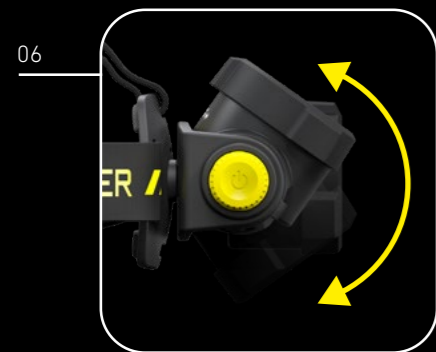
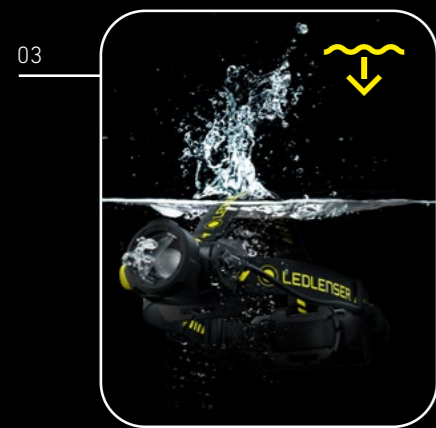

 2500 lm¹
 250 m¹
 70 h¹

- 01** – Extremely powerful, focusable work headlamp: **high color rendering, neutral white light**
- 02** – Strong **dust and water protection (IP67)**
- 03** – **Flicker-free** – Flicker-free, constant light enables strobe-free illumination, for fast-moving parts and machines
- 04** – **Protective elements on the lamp head and the end cap** absorb impacts and increase slip resistance; **the additional front lens cover** protects the lens from scratching
- 05** – Intuitive operation and stepless dimming thanks to **Wheel Switch** on the lamp head
- 06** – Stepless **swivel mechanism** for vertical alignment of the light cone
- 07** – **Ledsenser Connecting System** – an interface for many accessories (see page 108)
- 08** – **Extensive accessories** for versatile use, e.g. mounting clips, focusing ring, belt clip, transparent silicone headband, extension cord
- 09** – Convenient and safe charging of the battery thanks to the **Magnetic Charge System**

H-SERIES WORK

NEW

LED

△ LED-Configuration
▮ Light Functions
☀ Luminous flux ¹ (lm)
↔ Beam Distance ¹ (m)
🕒 Run Time ¹ (h)
🌡 Color temperature (K)
📊 Color rendering index (CRI)

BATTERY AND CASE

🔋 Battery
🔋 Battery Capacity ² (Wh / mAh)
🌧 IP Level
🔌 Rechargeable
🕒 Charging Time ⁵ (min)
↓ Drop height (m)

SIZE AND WEIGHT

📏 Head diameter (mm)
⚖ Weight incl. Battery (g / oz)

TECHNOLOGY

🌐 Multi-Core Optics
⚙ Flex Sealing Technology
🔌 Magnetic Charge System
🌞 Natural Light
🎯 Advanced Focus System

More features

PACKAGING

Item no. Box / GTIN

Contents Box

Price (MSRP) in €

OPTIONAL ACCESSORIES

[more accessories on page 108](#)



H5R WORK

H7R WORK

H15R WORK

1x High Power LED	1x Xtreme LED	1x Xtreme LED
Boost / Power / Low Power	Boost / Power / Low Power	Boost / Power / Low Power
500 / 300 / 15	1000 / 600 / 15	2500 / 1000 / 20
200 / 150 / 30	250 / 200 / 25	250 / 170 / 20
- / 2 / 45	- / 4 / 60	- / 4 / 70
3700 – 4400	3700 – 4400	3700 – 4400
80	90	90
1x Li-ion Batterypack 3,7V	1x 21700 Li-ion Battery 3,7V	1x Li-ion Batterypack 7,4V
6,66 / 1800	17,76 / 4800	35,52 / 4800
IP67	IP67	IP67
Yes	Yes	Yes
210	210	330
3	3	3
38	46	51
188 / 6,6	282 / 9,9	413 / 14,6
●	●	●
●	●	●
●	●	●
●	●	●
Cooling Technology, Temperature Control, Dimmable, Transportation Lock, Flicker-free, Memory Mode, Backup Mode, Battery Indicator, Charge Indicator, Low Battery Warning, Constant Light	Cooling Technology, Temperature Control, Dimmable, Transportation Lock, Flicker-free, Memory Mode, Backup Mode, Battery Indicator, Charge Indicator, Low Battery Warning, Constant Light	Cooling Technology, Dimmable, Transportation Lock, Flicker-free, Memory Mode, Backup Mode, Battery Indicator, Charge Indicator, Low Battery Warning, Constant Light
502194 / 4058205020992	502195 / 4058205021029	502196 / 4058205021050
1 battery set, magnetic charging cable, mounting clips, focusing ring, transparent silicone tape	1 battery set, magnetic charging cable, mounting clips, focusing ring, transparent silicone tape, extension cable, belt clip	1 battery set, magnetic charging cable, mounting clips, focusing ring, transparent silicone tape, extension cable, belt clip
89,90	119,00	189,00
502314 Helmet Connecting Kit Type H NEW	502262 21700 Li-Ion Rech. Bat. NEW	502256 Universal Mounting Bracket NEW
502247 Tripod Adapter Type D NEW	502410 Bluetooth® Batterybox NEW	502411 Bluetooth® Batterybox NEW

^{1,2} Information on page 184

ACCESSORIES

HEADLAMPS

H-SERIES WORK

NEW

LEDLENSER CONNECTING SYSTEM

MODEL	H5R WORK	H7R WORK	H15R WORK	Item no.	MSRP (€)
GoPro Adapter Type D NEW	•	•	•	502246	7,90
Tripod Adapter Type D NEW	•	•	•	502247	9,90
Belt Clip Type A NEW	•	•	•	502253	6,90
Helmet Connecting Kit H NEW	•	•	•	502314	14,90
Universal Mounting Bracket Type E NEW	•	•	•	502256	12,90

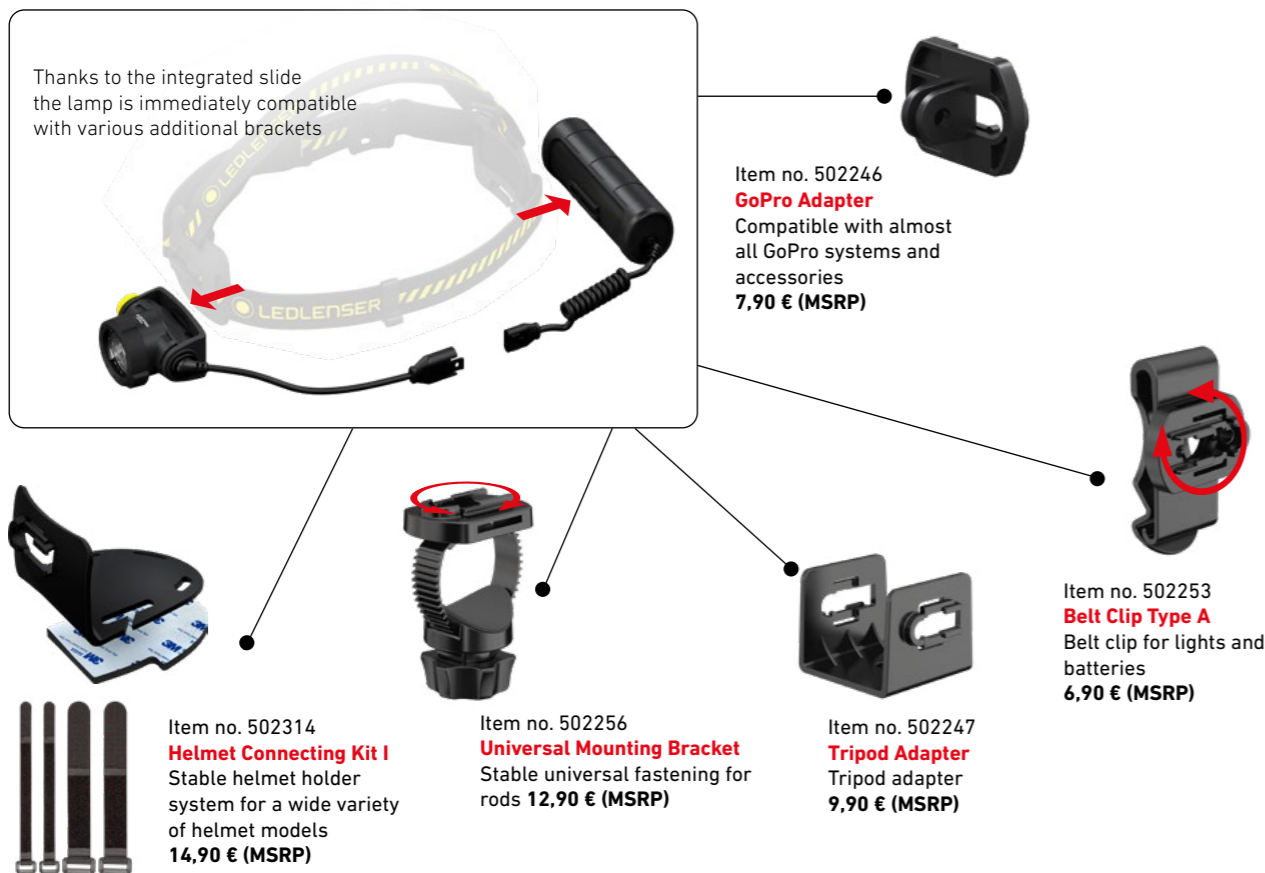

Thanks to the integrated slide the lamp is immediately compatible with various additional brackets

Item no. 502246
GoPro Adapter
Compatible with almost all GoPro systems and accessories
7,90 € (MSRP)

Item no. 502253
Belt Clip Type A
Belt clip for lights and batteries
6,90 € (MSRP)

Item no. 502314
Helmet Connecting Kit I
Stable helmet holder system for a wide variety of helmet models
14,90 € (MSRP)

Item no. 502256
Universal Mounting Bracket
Stable universal fastening for rods
12,90 € (MSRP)

Item no. 502247
Tripod Adapter
Tripod adapter
9,90 € (MSRP)

EVERYTHING ABOUT THE LEDLENSER CONNECTING SYSTEM ► S. 38



Multiple sizes / item no's. **NEW**
Color Filter Set
Four high quality color filters: Red maintains night vision. Green and red are among others suitable for wildlife viewing. Yellow improves visibility in fog. Blue improves the visibility of liquids
18,90 - 19,90 € (MSRP)



Item no. 502411 **NEW**
Bluetooth® 2x 21700 Batterybox
Upgrade to smart control: Bluetooth® Li-ion battery box for use with the Ledlenser Connect app or with the additional available remote control
59,90 € (MSRP)



Item no. 502312 **NEW**
Extension Cable
Practical extension cable (120 cm) that is plugged in between the lamp head and the battery box - so the battery can easily be stowed in the backpack
9,90 € (MSRP)



Item no. 502451 **NEW**
Transparent Silicone Headband
Elastic headband made of transparent silicone: Excellent grip, durability and easy to use. Due to the transparent material, safety-relevant information remains visible on the helmet
9,90 € (MSRP)

COLOR FILTERS / CABLES / BATTERIES AND MORE

MODEL	H5R WORK	H7R WORK	H15R WORK	Item no.	MSRP (€)
Color Filter Set 32mm NEW	•			502307	18,90
Color Filter Set 40mm NEW		•		502308	18,90
Color Filter Set 47mm NEW			•	502309	19,90
Headband with Overheadband CORE NEW	•	•	•	502469	9,90
Headband with Overheadband WORK NEW	•	•	•	502470	9,90
Headband with Overheadband SIGNATURE NEW	•	•	•	502471	12,90
Helmet Band Fixing Clips Type A NEW	•	•	•	502313	4,90
Transparent Silicone Headband Type A NEW	•	•	•	502451	9,90
Magnetic Charging Cable Type A NEW	•	•	•	502265	6,90
Extension Cable Type C NEW		•	•	502312	9,90
USB Adapter 2.4A NEW	•	•	•	502271	14,90
21700 Li-ion Rechargeable Battery 4800mAh NEW		•		502262	24,90
4x AA Alkaline Ionic			•	500980	3,49
2x 21700 Li-ion Rechargeable Battery Pack NEW			•	502310	39,90
Wireless Remote Control Type A NEW (can only be used in conjunction with a Bluetooth® Batterybox (502410, 502411))		•	•	502311	34,90
Bluetooth® 21700 Batterybox NEW		•		502410	49,90
Bluetooth® 2x 21700 Batterybox NEW		•	•	502411	59,90

iL-SERIES



iLH8

iLH8R

LED		
LED-Configuration	1x Xtreme LED	1x Xtreme LED
Light Functions	Power / Low Power	Power / Low Power
Luminous flux ¹ (lm)	280 / 60	300 / 50
Beam Distance ¹ (m)	160 / 80	160 / 70
Run Time ¹ (h)	9 / 38	7 / 40
BATTERY AND CASE		
Battery	3x Mignon (AA) Alkaline 1,5V	1x Li-ion Battery pack 3,7V
Battery Capacity ² (Wh / mAh)	–	12 / 3250
Rechargeable	No	Yes
Charging Time ⁵ (min)	–	540
IP Level	IP66 und IP68	IP66 und IP68
SIZE AND WEIGHT		
Head diameter (mm)	41	41
Weight incl. Battery (g / oz)	345 / 12,2	342 / 12,1
TECHNOLOGY		
Advanced Focus System	●	●
More features	Rear Light	Charge Indicator, Rear Light
CERTIFICATION		
EX-Zone	2/22	2/22
Gas and dust groups	IIC / IIIC	IIC / IIIC
Temperature class	T4/T135°C	T4/T135°C
PACKAGING		
Item no. Sleeve Box / GTIN	501019 / 4058205007474	501074 / 4058205008808
Contents Box	1 set of batteries, Battery Cartridge	1 set of batteries, charging station, power supply
Price (MSRP) in €	69,90	139,90
OPTIONAL ACCESSORIES		
	501595 Silicone Headband Type A	501595 Silicone Headband Type A
	500980 4x AA Alkaline Ionic	502261 5 Station Charging Panel
		0386 Car Charger

¹⁻⁷ Information on page 184

ROBUST LIGHT SOURCES FOR SAFE WORK CONDITIONS



ZONE 2/22

The industrial lights of the iL-series are specifically developed for work under harsh conditions. The lamps have maximum dust protection, are waterproof and also have explosion protection for EX-zone 2/22.

Therefore, they are particularly suitable for areas in which explosive atmospheres can occasionally occur or occupational safety regulations dictate that EX-protected lamps must be available.

Even when EX-protection is not required, these headlamps are great for work.

iH-SERIES



iH5



iH5R



LED		
LED-Configuration	1x High Power LED	1x High Power LED
Light Functions	Power / Low Power	Power / Low Power
Luminous flux ¹ (lm)	200 / 20	400 / 20
Beam Distance ¹ (m)	130 / 40	180 / 40
Run Time ¹ (h)	4,5 / 35	4 / 35
BATTERY AND CASE		
Battery	1x Mignon (AA) Alkaline 1,5V	1x 14500 Li-ion Battery 3,7V
Battery Capacity ²	–	2,77 / 750
Rechargeable	No	Yes
Charging Time ⁵ (min)	–	150
IP Level	IP54	IP54
SIZE AND WEIGHT		
Head diameter (mm)	31	31
Weight incl. Battery (g / oz)	92 / 3,2	98 / 3,5
TECHNOLOGY		
Magnetic Charge System		●
Smart Light Technology	●	●
Rapid Focus	●	●
Dual Power Source	●	●
Temperature Control		
Advanced Focus System	●	●
More features	Low Battery Warning, Mounting System	Low Battery Warning, Battery Indicator, Charge Indicator, Mounting System
PACKAGING		
Item no. Box / GTIN	502024 / 4058205015998	502025 / 4058205016025
Item no. Blister / GTIN	–	–
Contents Box	1 set of batteries	1 set of batteries, magnetic charging cable, helmet mount
Price (MSRP) in €	29,90	49,90
OPTIONAL ACCESSORIES		
	500985 14500 Li-ion rech.battery	0380 USB Car Charger
	500986 Charging Station	502220 Helmet Connecting Kit Type D
	502220 Helmet Connecting Kit Type D	500985 14500 Li-ion rech.battery
	502223 Helmet Connecting Kit Type G	500986 Charging station
		502093 Powercase NEW

more accessories on page 116

¹⁻⁷ Information on page 184

DYNAMIC HELPERS – INSPIRING FROM ANY ANGLE



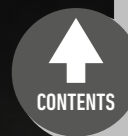
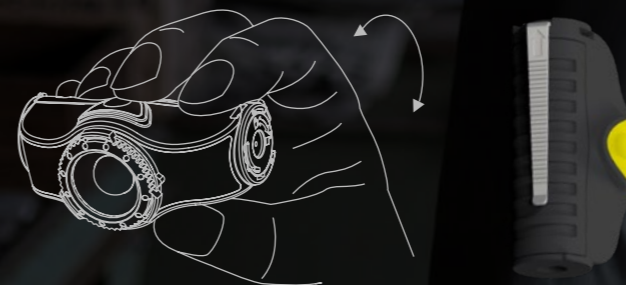

Mounting System

Thanks to the **innovative Mounting System**, the headlamp turns into a hand-held lamp or clip lamp in no time at all



iH11R



 1000 lm¹
 320 m¹
 100 h¹



06

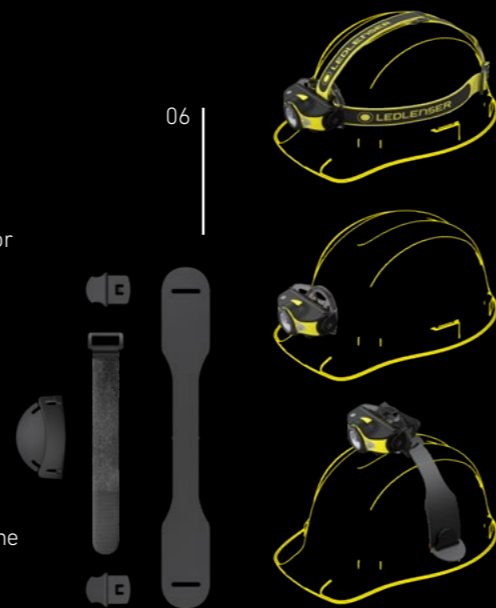

































 LEDLENSER CONNECT APP  Bluetooth®

- 01 – **Ledlenser Connect App** enables personalization and remote control of the light functions
- 02 – **Optisense Technology** – automatic adjustment of the lighting conditions thanks to the integrated sensor
- 03 – **Advanced Focus System** – stepless focusing
- 04 – Stepless **swivel mechanism** for vertical alignment of the light cone
- 05 – Additionally **red light, green light and blue light** available
- 06 – Various **mounting options** on helmets
- 07 – **Magnetic holder** to turn the iH11R into a hands free area light
- 08 – Convenient and safe charging of the battery thanks to the **Magnetic Charge System**



iH9R

iH11R

LED		
 LED-Configuration	1x Xtreme LED	1x Xtreme LED
 Light Functions	Boost / Power / Mid Power / Low Power (+ Blink)	Boost / Power / Mid Power / Low Power (+ Blink, S.O.S., Strobe)
 Luminous flux ¹ (lm)	600 / 400 / 170 / 20	1000 / 750 / 300 / 10
 Beam Distance ¹ (m)	200 / 180 / 120 / 40	320 / 300 / 200 / 30
 Run Time ¹ (h)	- / 7 / 10 / 60	- / 4 / 8 / 100
BATTERY AND CASE		
 Battery	1x Li-ion Batterypack 3,7V	1x 18650 Li-ion Battery 3,6V
 Battery Capacity ² (Wh / mAh)	5,73 / 1550	11,52 / 3200
 Rechargeable	Yes	Yes
 Charging Time ⁵ (min)	270	420
 IP Level	IP54	IP54
SIZE AND WEIGHT		
 Head diameter (mm)	31	40
 Weight incl. Battery (g / oz)	139 / 4,9	179 / 6,3
TECHNOLOGY		
 Magnetic Charge System		
 Smart Light Technology		
 Rapid Focus		
 Dual Power Source		
 Advanced Focus System		
 Cooling Technology		
 Optisense Technology		
More features	Energy Saving, Constant Light, Low Battery Warning, Charge Indicator, Battery Indicator, Transportation Lock, Red Light, Green Light, Blue Light	Energy Saving, Constant Light, Low Battery Warning, Charge Indicator, Battery Indicator, Transportation Lock, Dimmable, Red Light, Green Light, Blue Light, Bluetooth®, Memory Mode
PACKAGING		
Item no. Box / GTIN	502023 / 4058205015967	502022 / 4058205015936
Contents Box	1 battery set, magnetic charging cable, helmet mount	1 battery set, magnetic holder, belt pouch, helmet mount, magnetic charging cable, extended mounting set
Price (MSRP) in €	79,90	169,00
OPTIONAL ACCESSORIES		
	502221 Helmet Connecting Kit Type E	502126 Powerbank Flex3 NEW
more accessories on page 116	502093 Powercase NEW	501001 18650 Li-ion rech.Battery 3200 mAh

^{1,2} Information on page 184

WORK & PROFESSIONAL ACCESSORIES HEADLAMPS

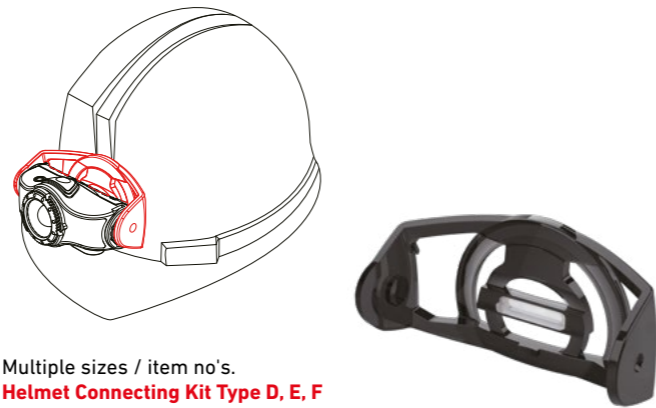

Multiple sizes / item no's.
Helmet Connecting Kit Type D, E, F
Simple helmet holder for front attachment to the helmet with an adhesive pad
9,90 € (MSRP)



Item no. 502223
Helmet Connecting Kit Type G
Helmet holder for attaching the headlamp to the helmet using a rubber band and plastic clips or adhesive pad
14,90 € (MSRP)

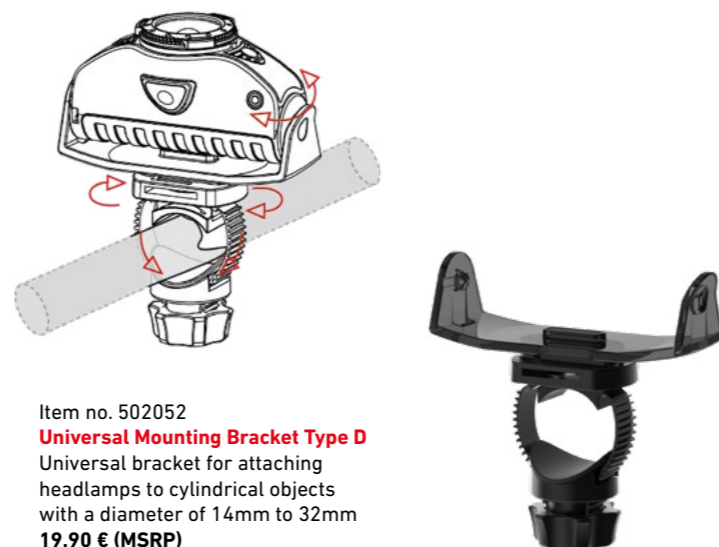

Item no. 502052
Universal Mounting Bracket Type D
Universal bracket for attaching headlamps to cylindrical objects with a diameter of 14mm to 32mm
19,90 € (MSRP)

ACCESSORIES POWER SUPPLY / BRACKETS AND MORE

MODEL	iLH8	iLH8R	iH5	iH5R	iH9R	iH11R	Item no.	MSRP (€)
Powercase NEW				●	●		502093	49,90
Powerbank Flex3 NEW						●	502126	34,90
Powerbank Flex7 NEW						●	502125	54,90
Batterybox7 NEW						●	502128	29,90
Helmet Connecting Kit Type D			●	●			502220	9,90
Helmet Connecting Kit Type E					●		502221	9,90
Helmet Connecting Kit Type F						●	502222	9,90
Helmet Connecting Kit Type G			●	●	●	●	502223	14,90
Helmet Band Fixing Clips Type A NEW			●	●	●	●	502313	4,90
Universal Mounting Bracket Type D						●	502052	19,90
Silicone Headband Type A	●	●					501595	9,90
5 Station Charging Panel		●					502261	69,90
Car Charger		●					0386	19,90
USB Car Charger				●	●	●	0380	9,90
USB Power Supply and Micro-USB Cable				●	●	●	0389	14,90
USB Adapter 2.4A				●	●	●	502271	14,90
18650 Li-ion Rechargeable Battery 3,6V 3000 mAh						●	501001	24,90
4x AA Alkaline Ionic		●	●	●	●		500980	3,49
Li-ion Rechargeable Battery Pack 3,7V 1550 mAh					●		500987	17,90
14500 Li-ion rechargeable battery 750 mAh			●	●			500985	12,90
Charging station & 14500 li-ion rechargeable battery			●	●			500986	18,90



Item no. 502093 **NEW**
Powercase
More information on page 175
49,90 € (MSRP)



Item no. 502126 **NEW**
Powerbank Flex3
More information on page 40
34,90 € (MSRP)



Item no. 502125 **NEW**
Powerbank Flex7
More information on page 40
54,90 € (MSRP)

— WORK & PROFESSIONAL WORKLIGHTS

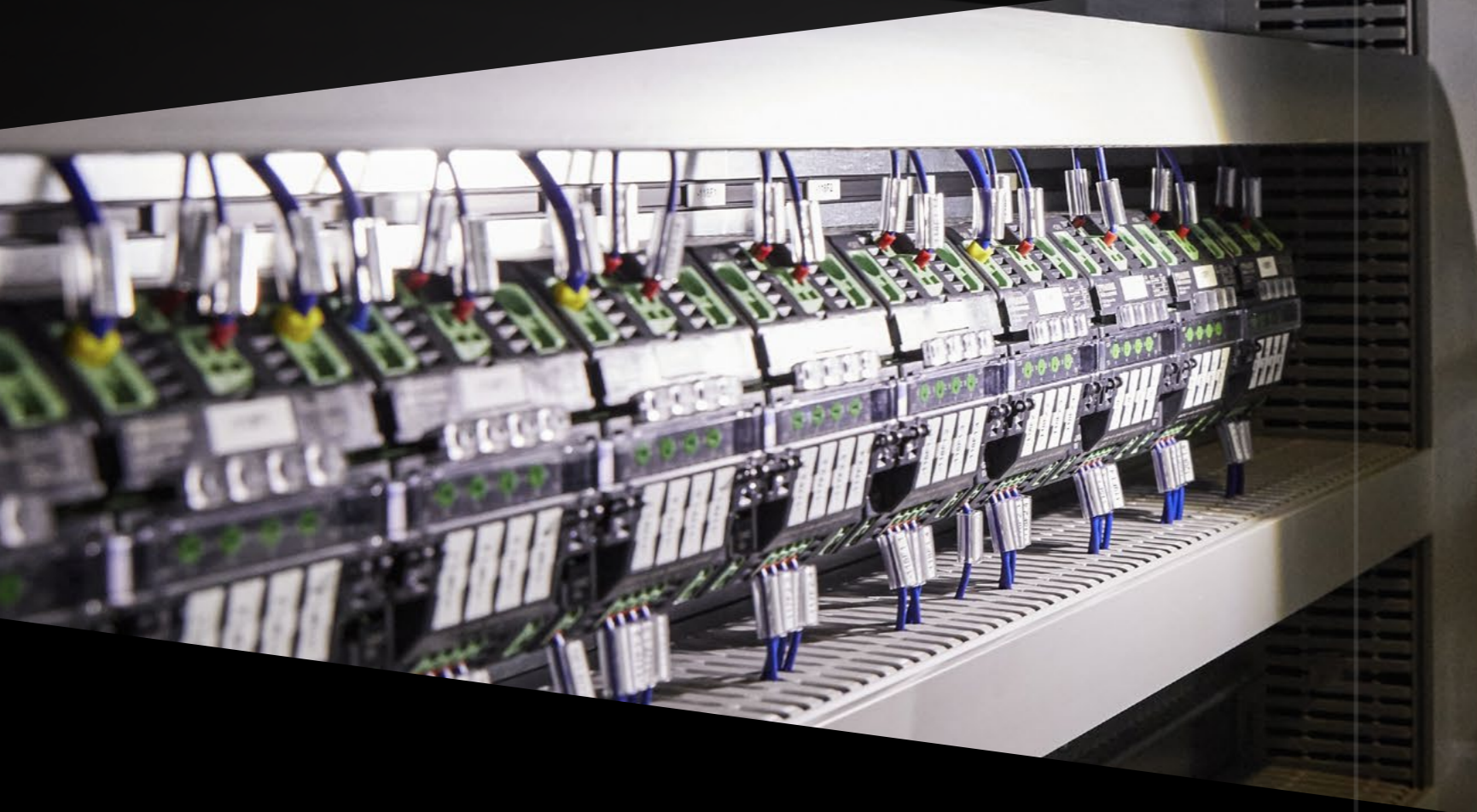







 **LEDLENSER**







iW-SERIES





LED

 LED-Configuration
 Light Functions
 Luminous flux Flood ¹ (lm)
 Run Time Flood ¹ (h)
 Luminous flux Spot ¹ (lm)
 Run Time Spot ¹ (h)

BATTERY AND CASE

 Battery
 Battery Capacity ² (Wh / mAh)
 Rechargeable
 Charging Time ⁵ (min)
 IP Level

SIZE AND WEIGHT

 W / H / D (mm)
 Weight incl. Battery (g / oz)

FEATURES

- 2-in-1 function: COB LED for wide flat illumination and spot LED for focused light
- Pen lamp: Rectangular
- Rounded metal housing with ruler function
- Extremely compact format and lightweight
- Rechargeable Lithium-ion battery
- Clip for attaching the lamp on the breast pocket

PACKAGING

Item no. Box / GTIN
Contents Box

Price (MSRP) in €

OPTIONAL ACCESSORIES

0380 USB Car Charger
502271 USB Adapter 2.4A

PORTABLE ILLUMINATING POWER FOR ANY APPLICATION



iW2R

1x COB LED (Flood), 1x Power LED (Spot)
Power / Low Power
150 / 75
1,5 / 3
100
1,5

iW2R laser

1x COB LED (Flood), 1x Laserpointer rot (650 nm)
Power / Low Power
150 / 75
1,5 / 3
Laser <1mW
-

iW3R

1x Power LED (Spot)
Power / Low Power
-
-
320 / 30
3,5 / 40

Li-ion Battery 3,7V (intern)	Li-ion Battery 3,7V (intern)	Li-ion Battery 3,7V (intern)
2,78 / 750	2,78 / 750	14,8 / 4000
Yes	Yes	Yes
180	180	300
IP20	IP20	IP54
18 / 164 / 16	18 / 164 / 16	32 / 122 / 32
50 / 1,8	50 / 1,8	143 / 5,0

- 2-in-1 function: COB LED for wide flat illumination and spot LED for focused light
- Pen lamp: Rectangular
- Rounded metal housing with ruler function
- Extremely compact format and lightweight
- Rechargeable Lithium-ion battery
- Clip for attaching the lamp on the breast pocket

- 2-in-1 function: laser pointer and COB-LED for wide area illumination
- Pen lamp: Rectangular
- Rounded metal housing with ruler function
- Extremely compact format and lightweight
- Rechargeable Lithium-ion battery
- Clip for attaching the lamp on the breast pocket

- Powerbank with 4000 mAh battery capacity
- Flashlight with spotlight
- Battery and Charge indicator
- Two dimming levels
- Covered connections, dust and water protected with IP54 rating

502082 / 4058205017824	502083 / 4058205017855	502173 / 4058205020176
USB cable	USB cable	USB cable
34,90	34,90	29,90
0380 USB Car Charger	0380 USB Car Charger	0380 USB Car Charger
502271 USB Adapter 2.4A	502271 USB Adapter 2.4A	502271 USB Adapter 2.4A

iW5R flex

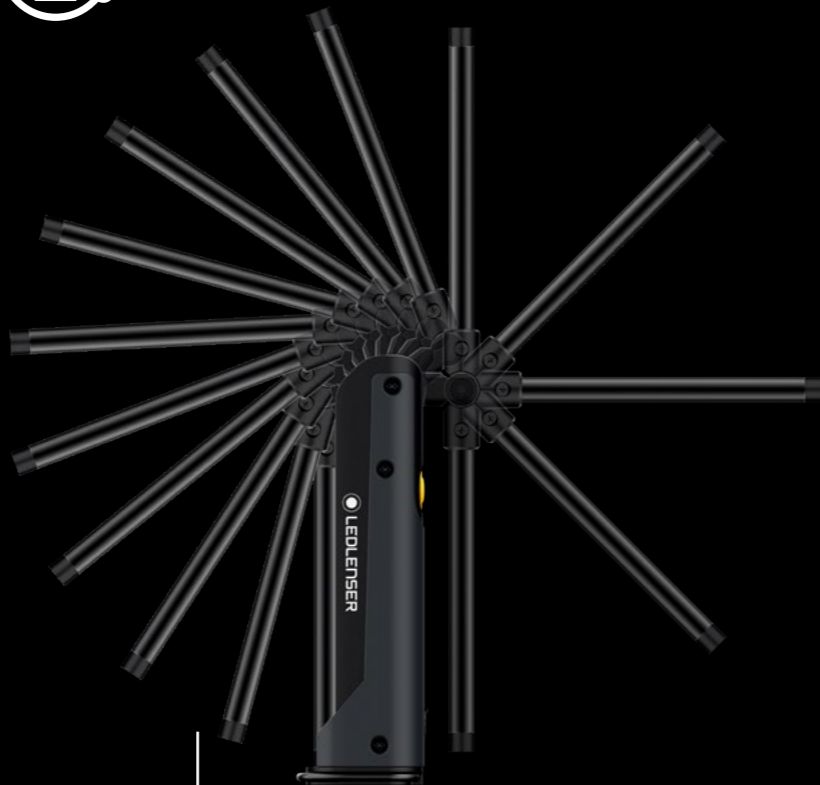
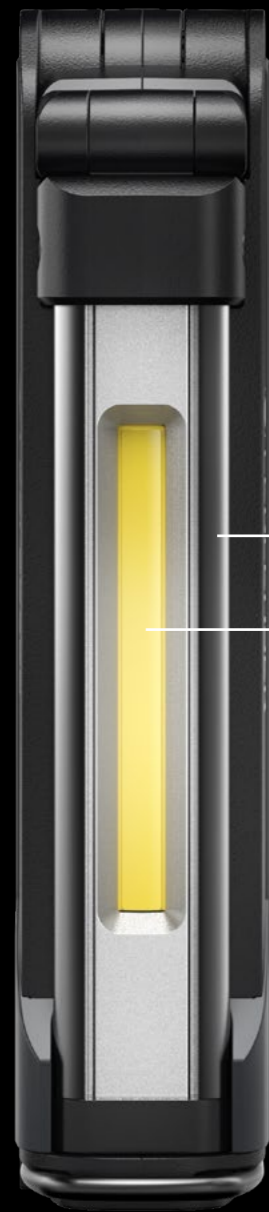

01

02

02

☀ 600 lm¹
🕒 6,5 h¹

- 01** – Folding, slim lamp head for inaccessible spaces with a wide casting floodlight
- 02** – Two light sources:
 - 1. Spotlight: a brightness level
 - 2. Floodlight: even light distribution with two brightness levels (chip-on-board technology)
- 03** – Rechargeable via USB
- 04** – Battery and charging level indicator
- 05** – Magnet and hook for various attachment options

05



WORKLIGHT FOR TIGHT SPACES



FLEXIBLE WORK LIGHTS WITH TWO LIGHT SOURCES



LED		
LED-Configuration	1x COB LED (Flood), 1x Power LED (Spot)	1x COB LED (Flood), 1x Power LED (Spot)
Light Functions	Power / Low Power (Flood)	Power / Low Power (Flood)
Luminous flux Flood ¹ (lm)	150 / 75	600 / 250
Run Time Flood ¹ (h)	2 / 4	2 / 4
Luminous flux Spot ¹ (lm)	75	100
Run Time Spot ¹ (h)	2	6,5
BATTERY AND CASE		
Battery	Li-ion Battery 3,7V (intern)	Li-ion Battery 3,7V (intern)
Battery Capacity ² (Wh / mAh)	2,8 / 750	9,6 / 2600
Rechargeable	Yes	Yes
Charging Time ⁵ (min)	150	240
IP Level	IP54	IP52
SIZE AND WEIGHT		
W / H / D (mm)	27 / 157 / 20	40 / 151 / 32
Weight incl. Battery (g / oz)	72 / 2,5	220 / 7,8
FEATURES		
	<ul style="list-style-type: none"> • Tilt mechanism for flexible align • 2 light sources (spot and flood) • Mounting magnet • Battery level indicator • Charge indicator 	<ul style="list-style-type: none"> • Fold-out lamp head • 2 light sources (spot and flood) • Hook and mounting magnet • Battery level indicator • Charge indicator
PACKAGING		
Item no. Box / GTIN	502003 / 4058205016261	502006 / 4058205016353
Contents Box	USB cable	USB cable, USB power adapter
Price (MSRP) in €	39,90	79,90
OPTIONAL ACCESSORIES		
	0380 USB Car Charger	0380 USB Car Charger
	502271 USB Adapter 2.4A	502271 USB Adapter 2.4A



LED	
LED-Configuration	1x COB LED (Flood), 1x High Power LED (Spot)
Light Functions	Power / Low Power (Flood)
Luminous flux Flood ¹ (lm)	300 / 125
Run Time Flood ¹ (h)	3 / 6
Luminous flux Spot ¹ (lm)	300
Run Time Spot ¹ (h)	2,5
Run Time Spot ¹ (h)	3
BATTERY AND CASE	
Battery	Li-ion Battery 3,7V (intern)
Battery Capacity ² (Wh / mAh)	8,1 / 2200
Rechargeable	Yes
Charging Time ⁵ (min)	210
IP Level	IP54
SIZE AND WEIGHT	
W / H / D (mm)	39 / 159 / 35
Weight incl. Battery (g / oz)	168 / 5,9
FEATURES	
	<ul style="list-style-type: none"> • 2 light sources (spot and flood) • Hook with tilt mechanism and mounting magnet • Charging via USB cable • Battery level indicator • Charge indicator
	<ul style="list-style-type: none"> • Charging via charging station • 2 light sources (spot and flood) • Hook with tilt mechanism and mounting magnet • Battery level indicator • Charge indicator
PACKAGING	
Item no. Box / GTIN	502004 / 4058205016292
Contents Box	USB cable, USB power adapter
Item no. Box / GTIN	502005 / 4058205016322
Contents Box	Charging station, USB cable, USB power adapter
Price (MSRP) in €	69,90
Price (MSRP) in €	99,90
OPTIONAL ACCESSORIES	
	0380 USB Car Charger
	502271 USB Adapter 2.4A
	502261 5 Station Charging Panel
	502271 USB Adapter 2.4A
	0380 USB Car Charger

iW5R



- 01 – Floodlight
- 02 – Spotlight
- 03 – Magnetic hook for fixing
- 04 – Battery and charging level indicator

— WORK & PROFESSIONAL FLOODLIGHTS



 **LEDLENSER**

WORK & PROFESSIONAL



POCKET SIZE RECHARGEABLE WORK-SITE FLOODLIGHTS



LED

LED-Configuration
Light Functions
Luminous flux Flood ¹ (lm)
Run Time Flood ¹ (h)
Luminous flux Spot ¹ (lm)
Run Time Spot ¹ (h)

BATTERY AND CASE

Battery
Battery Capacity ² (Wh / mAh)
Rechargeable
Charging Time ⁵ (min)
IP Level

SIZE AND WEIGHT

W / H / D (mm)
Weight incl. Battery (g / oz)

FEATURES

PACKAGING

Item no. Box / GTIN
Contents Box

Price (MSRP) in €

OPTIONAL ACCESSORIES

iF2R



iF3R



1x COB LED (Flood), 1x Power LED (Spot)	1x COB LED (Flood)
Power / Low Power (Flood)	Five light levels
200 / 100	1000 / 750 / 500 / 250 / 100
3 / 6	1,5 / 2 / 3 / 5 / 15
75	-
4	-
Li-ion Battery 3,7V (intern)	Li-ion Battery 3,7V (intern)
5,9 / 1600	14,8 / 4000
Yes	Yes
180	300
IP54	IP54
115 / 21 / 48	36 / 140 / 71
88 / 3,1	392 / 13,8

- **Mini floodlights with floodlight** and additional **spotlight**
- **Flexible attachment** and alignment thanks to the movable stand, Magnet and hook
- Easy charging with the robust **Magnetic Charge System**
- Small and handy
- **Three light levels (2x flood, 1x spot)**

- **Small floodlights** with outstanding light output
- Flexible attachment and alignment thanks to the **movable stand, magnet and hook**
- Easy charging with the robust **Magnetic Charge System**
- **Cooling Technology** for long-term operation without overheating
- **Five levels of light**

502170 / 4058205020206	502171 / 4058205020237
USB cable	USB power supply, magnetic charging cable
49,90	89,90
502265 Magnetic Charging Cable Type A	502265 Magnetic Charging Cable Type A
502271 USB Adapter 2.4A	502271 USB Adapter 2.4A
0380 USB Car Charger	0380 USB Car Charger

^{1,2} Information on page 184



iF2R



- 01 – Floodlight
- 02 – Spotlight
- 03 – Magnetic hook for fixing
- 04 – Battery and charging level indicator
- 05 – Magnetic Charge System

iF4R music

NEW

 2500 lm¹
 15 h¹





Bluetooth®

- 01 – Built-in speaker with Bluetooth® control
- 02 – Five brightness settings
- 03 – Built-in magnet for easy attachment to metal surfaces (e.g. steel beams)
- 04 – Easy charging via **Magnetic Charge System**
- 05 – **Large, tough handle** for easy transport
- 06 – **Multifunctional Switch** - for quick and easy control of individual light functions



iF8R



 4500 lm¹
 12 h¹



Bluetooth®

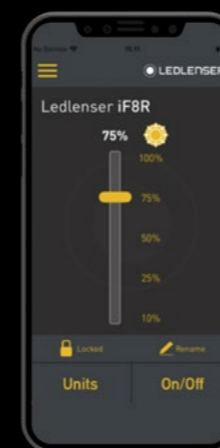





- 01 – Rechargeable
- 02 – **App-controlled:** with the app, up to four lamps can be remotely controlled
- 03 – **Powerbank function**
- 04 – **Built-in magnet** for easy attachment
- 05 – **Cooling Technology** – efficient cooling element for a long life and optimum performance
- 06 – **Five brightness levels**
- 07 – **Multifunctional Switch** - for quick and easy control of individual light functions
- 08 – Chip-on-board-Technology
- 09 – Easy to transport thanks to the large, robust handle







iF8R 





LED

-  LED-Configuration
-  Light Functions
-  Luminous flux¹ (lm)
-  Run Time¹ (h)



BATTERY AND CASE

-  Battery
-  Battery Capacity² (Wh / mAh)
-  Rechargeable
-  Charging Time⁵ (min)
-  IP Level

SIZE AND WEIGHT

-  W / H / D (mm)
-  Weight incl. Battery (g / oz)

TECHNOLOGY

-  Magnetic Charge System
-  Powerbank Function
-  Cooling Technology

More features

PACKAGING

Item no. Box / GTIN

Contents Box

Price (MSRP) in €

OPTIONAL ACCESSORIES

ULTRA BRIGHT WORK-SITE FLOODLIGHTS WITH POWERBANK FUNCTION OR MUSIC BOX



iF4R

NEW



iF4R music



iF8R

1x 34W COB LED	1x 34W COB LED	1x 66W COB LED
Five light levels	Five light levels	Five light levels
2500 / 1500 / 1000 / 500 / 200	2500 / 1500 / 1000 / 500 / 200	4500 / 3000 / 2000 / 1000 / 400
1,3 / 2 / 3 / 6 / 15	1,3 / 2 / 3 / 6 / 15	1,25 / 1,5 / 2,5 / 5 / 12
Li-ion Battery 3,7V (intern)	Li-ion Battery 3,7V (intern)	Li-ion Battery 3,7V (intern)
29,6 / 8000	29,6 / 8000	44,4 / 4000
Yes	Yes	Yes
240	360	240
IP54	IP54	IP54
235 / 111 / 44	235 / 110 / 47	307 / 142 / 44
1060 / 37,4	1139 / 40,2	1740 / 61,4
●	●	●
●		●
Charge Indicator, Battery Indicator, Magnet, Stand	Charge Indicator, Battery Indicator, Transportation Lock, Bluetooth® Speaker, Magnet, Magnetic Charge System	Charge Indicator, Battery Indicator, Bluetooth®, Magnet, Stand
502001 / 4058205016209	502172 / 4058205020268	502002 / 4058205016230
USB cable, USB power supply	USB power supply, magnetic charging cable	Power adapter
139,00	189,00	199,00
502271 USB Adapter 2.4A	502265 Magnetic Charging Cable Type A	
0380 USB Car Charger	502271 USB Adapter 2.4A	
	0380 USB Car Charger	



— WORK & PROFESSIONAL INTRINSICALLY SAFE LAMPS



FOR
EXPLOSIVE
WORKING
AREA

Ex

 LEDLENSER

WORK & PROFESSIONAL



FOR MAXIMUM SAFETY AT THE WORKPLACE

If you work in explosive environments, safety is extremely important when it comes to using electronics.

Ledlenser EX- and iL-series lights meet these standards in every aspect. Designed specifically for contact with explosive gases, vapors and dust in the best possible groups IIC and IIIC. They feature maximum dust protection, are protected from water and ATEX and IECEx approved.

Yet both lines - in compliance with the ATEX operating directives - are designed for different types of explosion hazards.

The **EX-series** is suitable for use in areas where explosive atmospheres are frequently present (zones 0, 1, 20 or 21) and the **iL-series** (more on page 98 and 110) for zones 2/22¹. So you'll find the perfect lamp for any environment.

EXAMPLE FIELDS OF APPLICATION:

- Oil and gas drilling rig
- Gas, oil and coal-fired power plant
- Chemical park
- Storage site for oil and gas
- Petrol station and road tankers
- Sewerage and sewage treatment plant
- Paint shop and car repair shop
- Pharmaceutical factory
- Food factory
- Distillery
- Sawmill
- u.v.m.



¹ Depending on gases and/or dust present.

A glance at the ATEX Directive of the European Union

From oil and gas production facilities to chemical plants and distilleries as well as sawmills and bakeries: The so-called ATEX Directive applies to all businesses within the EU, in which explosive atmospheres can arise due to gas or dust. At the same time, the work areas are divided into zones according to the frequency and duration of the risk of explosion.

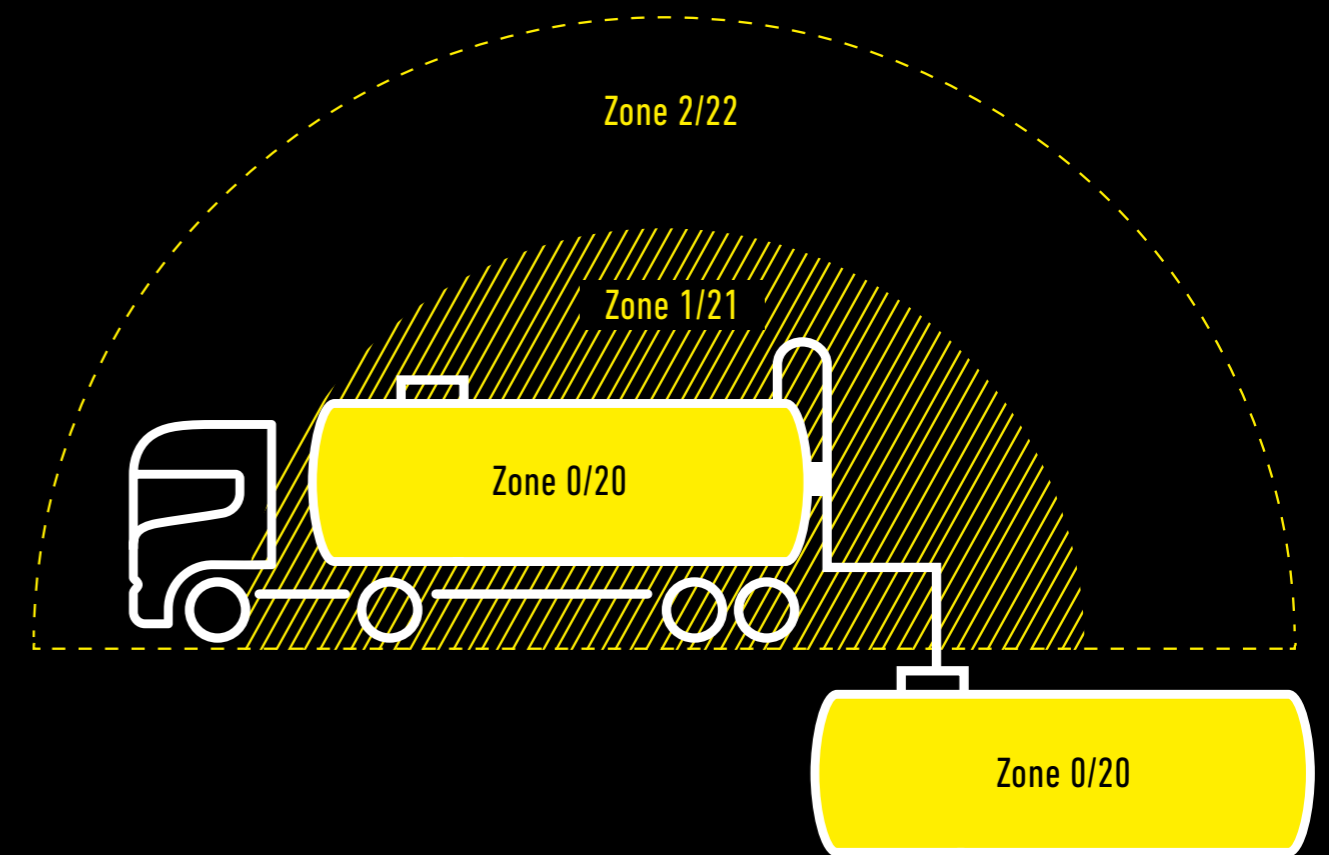

A place in which an explosive atmosphere consisting of a mixture with air of dangerous substances in the form of gas, vapor or a cloud of combustible dust is **continuously present** for long periods or frequently (e.g. in gas tanks or grain elevators).



Working areas in which explosive atmospheres in the form of flammable gases, vapors or dust clouds prevail **occasionally**.





Working areas in which explosive atmospheres in the form of flammable gases, vapors or dust clouds (e.g. in case of a gas leak) **usually do not prevail / prevail only for a short time**.

EX7R 

ADVANTAGE IS A MATTER OF TECHNOLOGY



 220 lm¹
 140 m¹
 45 h¹

**ZONE
1/21**



ADVANCED FOCUS SYSTEM

- 01 – Suitable for the highest gas and dust groups (IIC/IIIC)
- 02 – **Magnetic Switch** for easy operation with gloves and protective equipment
- 03 – Dustproof and protected against powerful water jets (IP66 and IP68)
- 04 – **Advanced Focus System** – stepless focusing
- 05 – **Rechargeable** via charging cradle



¹⁻⁷ Information on page 184





EX4

EX7

LED		
LED-Configuration	1x Power LED	1x Power LED
Light Functions	Power	Power / Low Power
Luminous flux ¹ (lm)	50	200 / 60
Beam Distance ¹ (m)	35	120 / 70
Run Time ¹ (h)	7	16 / 45
BATTERY AND CASE		
Battery	2x Micro (AAA) Alkaline 1,5V	3x Mignon (AA) Alkaline 1,5V
Battery Capacity ²	-	-
Rechargeable	No	No
Charging Time ⁵ (min)	-	-
IP Level	IP66 and IP68	IP66 and IP68
SIZE AND WEIGHT		
Head diameter (mm)	20	41
Length (mm)	140	161
Weight incl. Battery (g / oz)	65 / 2,3	232 / 8,2
TECHNOLOGY		
Advanced Focus System		●
More features	-	-
CERTIFICATION		
EX-Zone	0/20	0/20
Gas group	IIA, IIB, IIC	IIA, IIB, IIC
Dust group	IIIA, IIIB, IIIC	IIIA, IIIB, IIIC
Temperature class	T4/T ₂₀₀ 135°C	T4/T ₂₀₀ 135°C
PACKAGING		
Item no. Sleeve Box / GTIN	500682 / 4058205000437	500836 / 4058205001243
Contents Box	1 set of batteries	1 set of batteries, belt clip, Intelligent clip
Price (MSRP) in €	39,90	89,90
OPTIONAL ACCESSORIES		
	500954 Helmet Mount Type A	500957 Intelligent Clip Type G
	500955 Helmet Mount Type B	500958 Signal Cone 42mm
	500956 Intelligent Clip Type F	

more accessories on page 142



EX7R

EXH8

EXH8R

LED			
LED-Configuration	1x Power LED	1x Power LED	1x Power LED
Light Functions	Power / Low Power	Power / Low Power	Power / Low Power
Luminous flux ¹ (lm)	220 / 50	180 / 50	200 / 45
Beam Distance ¹ (m)	140 / 65	120 / 65	130 / 60
Run Time ¹ (h)	10 / 45	15 / 40	10 / 45
BATTERY AND CASE			
Battery	1x Li-ion Battery pack 3,7V	3x Mignon (AA) Alkaline 1,5V	1x Li-ion Battery pack 3,7V
Battery Capacity ²	12 / 3250	-	12 / 3250
Rechargeable	Yes	No	Yes
Charging Time ⁵ (min)	660	-	660
IP Level	IP66 and IP68	IP66 and IP68	IP66 and IP68
SIZE AND WEIGHT			
Head diameter (mm)	41	41	41
Length (mm)	161		
Weight incl. Battery (g / oz)	228 / 8,0	345 / 12,2	342 / 12,1
TECHNOLOGY			
Advanced Focus System	●	●	●
More features			
Charge Indicator		Rear Light	Charge Indicator, Rear Light
CERTIFICATION			
EX-Zone	1/21	0/20	1/21
Gas group	IIA, IIB, IIC	IIA, IIB, IIC	IIA, IIB, IIC
Dust group	IIIA, IIIB, IIIC	IIIA, IIIB, IIIC	IIIA, IIIB, IIIC
Temperature class	T4/T135°C	T4/T ₂₀₀ 135°C	T4/T135°C
PACKAGING			
Item no. Sleeve Box / GTIN	500837 / 4058205001274	501017 / 4058205007412	501018 / 4058205007443
Contents Box	1 set of batteries, belt clip, intelligent clip, charging station, power supply	1 set of batteries, Battery Cartridge	1 set of batteries, charging station, power supply
Price (MSRP) in €	169,90	89,90	169,90
OPTIONAL ACCESSORIES			
	500957 Intelligent Clip Type G	501595 Silicone Headband Type	501595 Silicone Headband Type
	500958 Signal Cone 42mm		502261 5 Station Charging Panel
	502261 5 Station Charging Panel		0386 Car Charger
	0386 Car Charger		

¹⁻⁷ Information on page 184



WORK & PROFESSIONAL
ACCESSORIES

EX-FLASHLIGHTS

MODEL	EX7	EX7R	EX4	Item no.	MSRP (€)
Signal Cone Orange 42 mm	●	●		500958	6,90
Car Charger		●		0386	19,90
5 Station Charging Panel		●		502261	69,90
Helmet Mount Type A			●	500954	19,90
Helmet Mount Type B			●	500955	19,90
Intelligent Clip Type F			●	500956	8,90
Intelligent Clip Type G	●	●		500957	8,90

Item no. 500956
Intelligent Clip Type F
Belt clip for EX4 with ball joint, can be any way aligned
8,90 € (MSRP)



Item no. 500957
Intelligent Clip Type G
Belt clip for EX7 and EX7R with ball joint, can be any way aligned
8,90 € (MSRP)



EX-HEADLAMPS

MODEL	EXH8	EXH8R	Item no.	MSRP (€)
Car Charger		●	0386	19,90
5 Station Charging Panel		●	502261	69,90
Silicone Headband Type A	●	●	501595	9,90



Item no. 502261
5 Station Charging Panel
Allows simultaneous charge up to five EX7Rs and EXH8R
69,90 € (MSRP)



Item no. 500954
Helmet Mount Type A
The bracket fits most helmet models (max. 12 mm thick). The light beam can be flexibly aligned using the ball joint. Suitable for the EX4 penlamp
19,90 € (MSRP)



Item no. 500955
Helmet Mount Type B
Bracket with the same concept as the Helmet Mount Type A, in which the lamp moves a little further up. Suitable for the EX4 penlamp
19,90 € (MSRP)



— OUTDOOR & SPORTS FLASHLIGHTS



HIGH RANGE MEETS HIGH
LEVEL OF ENDURANCE

 LEDLENSER



P7R SIGNATURE



NEW

THE NEW P-SERIES PERFECT HIGH-END LIGHT

☀️ 2000 lm¹
🔦→ 330 m¹
🕒 90 h¹



516



Contents



- 01** – Powerful premium flashlight with **natural color rendering (80 CRI / 6500K)**
- 02** – **Mode Switch** for direct access to personalized light functions thanks to Smart Light Technology
- 03** – Additional **Red secondary light** on the side of the housing, e.g. to maintain the night vision in the dark
- 04** – **Hard-anodized housing material** for additional protection against wear and corrosion
- 05** – Extreme **dust and water protection (IP68)**
- 06** – **Flex Sealing Technology** – can be used for a short time underwater (including the focusing system) to a depth of one meter
- 07** – Personalize the light functions thanks to **Smart Light Technology**
- 08** – **Constant Light** – consistent level of brightness over time
- 09** – Integrated **battery and charge status display**

¹ Information on page 184



MAXIMUM PERFORMANCE IN A CLASSY DESIGN



P6R SIGNATURE



P7R SIGNATURE



P18R SIGNATURE

LED		
LED-Configuration	1x Xtreme LED, (1x red LED)	1x Xtreme LED, (1x red LED)
Light Functions	Boost / Power / Mid Power / Low Power (+ Position, Blink, S.O.S., Strobe, Red light)	Boost / Power / Mid Power / Low Power (+ Position, Blink, S.O.S., Strobe, Red light)
Luminous flux ¹ (lm)	1400 / 1100 / 450 / 15	2000 / 1200 / 500 / 15
Beam Distance ¹ (m)	240 / 190 / 110 / 20	330 / 200 / 130 / 20
Run Time ¹ (h)	- / 1,25 / 2,5 / 60	- / 2 / 3,25 / 90
Color temperature (K)	6000 - 7500	6000 - 7500
Color rendering index (CRI)	80	80
BATTERY AND CASE		
Battery	1x 18650 Li-ion Battery 3,6V	1x 21700 Li-ion Battery 3,7V
Battery Capacity ² (Wh / mAh)	10,89 / 3000	17,76 / 4800
IP Level	IP68	IP68
Rechargeable	Yes	Yes
Charging Time ⁵ (min)	225	270
Drop height (m)	2	2
SIZE AND WEIGHT		
Length – defocused (mm)	151	158
Head diameter (mm)	35	35
Weight incl. Battery (g / oz)	170 / 6,0	202 / 7,1
TECHNOLOGY		
Smart Light Technology	●	●
Flex Sealing Technology	●	●
Magnetic Charge System	●	●
Multi-Core Optics	●	●
Advanced Focus System	●	●
More features	Red Alternate Light, Mode Switch, Emergency Light, Temperature Control, Dimmable, Transportation Lock, Flicker-free, Memory Function, Backup Mode, Emergency Light, Battery Indicator, Charge Indicator, Low Battery Warning	Red Alternate Light, Mode Switch, Emergency Light, Temperature Control, Dimmable, Transportation Lock, Flicker-free, Memory Function, Backup Mode, Emergency Light, Battery Indicator, Charge Indicator, Low Battery Warning
PACKAGING		
Item no. Box / GTIN	502189 / 4058205020756	502190 / 4058205020787
Contents Box	1 set of batteries, leather belt pouch, lanyard, magnetic charging cable, pocket clip, USB power adapter, wall bracket	1 set of batteries, leather belt pouch, lanyard, magnetic charging cable, pocket clip, USB power adapter, wall bracket
Price (MSRP) in €	129,00	159,00
OPTIONAL ACCESSORIES		
more accessories on page 150	502250 Lamp Adapter Type C	502251 Lamp Adapter Type D

3x Xtreme LED	
LED-Configuration	3x Xtreme LED
Light Functions	Boost / Power / Mid Power / Low Power (+ Position, Blink, S.O.S., Strobe)
Luminous flux ¹ (lm)	4500 / 2600 / 1000 / 30
Beam Distance ¹ (m)	720 / 420 / 260 / 50
Run Time ¹ (h)	- / 2,5 / 4,5 / 70
Color temperature (K)	6000 - 7200
Color rendering index (CRI)	70
1x Li-ion Battery pack 11,1V	
Battery	1x Li-ion Battery pack 11,1V
Battery Capacity ² (Wh / mAh)	33,3 / 3000
IP Level	IP54
Rechargeable	Yes
Charging Time ⁵ (min)	330
Drop height (m)	1
X-Lens Technology, Rapid Focus, Dimmable, Transportation Lock, Flicker-free, Memory Function, Backup Mode, Emergency Light, Battery Indicator, Charge Indicator, Low Battery Warning	
Item no. Box / GTIN	502191 / 4058205020817
Contents Box	1 set of batteries, lanyard, USB power adapter, magnetic charging cable
Price (MSRP) in €	249,00
OPTIONAL ACCESSORIES	501508 Color Filter Red 85.5mm

P-SERIES SIGNATURE NEW



← THE NEW P-SERIES CORE FROM PAGE 52

THE NEW P-SERIES WORK FROM PAGE 88

EVERYTHING ABOUT THE CORE-WORK-SIGNATURE CONCEPT FROM PAGE ► 22

ACCESSORIES

FLASHLIGHTS

P-SERIES SIGNATURE

NEW

LEDLENSER CONNECTING SYSTEM

MODEL	P6R SIGNATURE	P7R SIGNATURE	Item no.	MSRP (€)
Lamp Adapter Type C NEW	•		502250	4,90
Lamp Adapter Type D NEW		•	502251	4,90
GoPro Adapter Type D NEW	•	•	502246	7,90
Tripod Adapter Type D NEW	•	•	502247	9,90
Belt Clip Type A NEW	•	•	502253	6,90
Helmet Mount for Euroslot Type A NEW	•	•	502254	6,90
Flexible Mount Type A NEW	•	•	502255	14,90
Universal Mounting Bracket Type E NEW	•	•	502256	12,90

Lamp Adapter Type A-D

Mounting adapter
(Requirement)

The adapter enables the connection between flashlights and the versatile **LEDlenser connecting system**. Now the light is compatible with various additional accessory brackets and mounts.



Diverse Item no. 4,90 € (MSRP)



Item no. 502246
GoPro Adapter
Compatible with almost all GoPro systems and accessories
7,90 € (MSRP)



Item no. 502255
Flexible Mount
Flexible fastening system with magnet, adhesive pad and hole to screw on
14,90 € (MSRP)



Item no. 502254
Helmet Mount for Euroslot
Helmet mount for 30 mm Euroslot 6,90 € (MSRP)



Item no. 502256
Universal Mounting Bracket
Stable universal fastening for rods 12,90 € (MSRP)



Item no. 502247
Tripod Adapter
Tripod adapter 9,90 € (MSRP)



Item no. 502253
Belt Clip Type A
Practical belt clip for flights and batteries 6,90 € (MSRP)

EVERYTHING ABOUT THE LEDLENSER CONNECTING SYSTEM ► P. 32



Item no. 502126
Powerbank Flex3
More information on page 40
34,90 € (MSRP)



Item no. 502125
Powerbank Flex7
More information on page 40
54,90 € (MSRP)



Item no. 502128
Batterybox7
More information on page 40
29,90 € (MSRP)



Diverse Item no.
Charging Station
professional charging station
Including magnetic charging cable, compatible with 5 Station Charging Panel
12,90 € (MSRP)



Item no. 502261
5 Station Charging Panel
Charge up to five compatible Ledlenser Lamps (requirement: suitable charging station)
69,90 € (MSRP)

ACCESSORIES POWER SUPPLY

MODEL	P6R SIGNATURE	P7R SIGNATURE	P18R SIGNATURE	Item no.	MSRP (€)
Powerbank Flex3 NEW	•			502126	34,90
Powerbank Flex7 NEW	•			502125	54,90
Batterybox7 NEW	•			502128	29,90
Magnetic Charging Cable Type A NEW	•	•	•	502265	6,90
Wall Mount Type A NEW (including magnetic charging cable)	•			502257	9,90
Wall Mount Type B NEW (including magnetic charging cable)		•		502258	9,90
Charging Station Type B NEW (including magnetic charging cable)	•	•		502260	12,90
5 Station Charging Panel NEW	•	•		502261	69,90
USB Adapter 2.4A NEW	•	•	•	502271	14,90
USB Car Charger	•	•	•	0380	9,90
21700 Li-ion rechargeable battery 4800mAh NEW		•		502262	24,90
18650 Li-ion rechargeable Battery 3000 mAh	•			501001	24,90

ACCESSORIES

FLASHLIGHTS

P-SERIES SIGNATURE

POUCHES / FILTERS / HOLDERS AND MORE

MODEL	P6R SIGNATURE	P7R SIGNATURE	P18R SIGNATURE	Item no.	MSRP (€)
Color Filter Set 35.1mm	•	•		502238	19,90
Color Filter Blue 85.5mm			•	501507	24,90
Color Filter Red 85.5mm			•	501508	24,90
Color Filter Green 85.5mm			•	501509	24,90
Color Filter Yellow 85.5mm			•	501510	24,90
Signal Cone 35.1mm	•	•		502237	9,90
Signal Cone White 35.1mm	•	•		502243	9,90
Roll Protection 85,5mm			•	502242	14,90
Case Type A NEW	•	•		502263	24,90
Case Type B NEW	•	•		502264	29,90
Pouch Type G	•	•		0342	9,90
Leather Pouch Type D	•	•		502269	19,90
Universal Mounting Bracket Type B	•	•		7799-PT	15,90
Universal Mounting System	•	•		0362	14,90



Diverse Item no. **Color filter one color each**
Color filter with roll protection. Red reduces e.g. Reflections and maintains night vision. Green and red are among others suitable for wildlife viewing. Yellow improves visibility in fog. Blue improves the visibility of traces and liquids
24,90 € (MSRP)



Item no. 0362 **Universal Mounting System**
This universal mounting fixes flashlights with a diameter of 25-34 mm securely to tripods, rods and tubes in next to no time. The light and fixation are aligned in parallel
14,90 € (MSRP)



NEW

Item no. 502263

Case Type A

Soft case transport bag: Inside there are elastic loops and a mesh pocket to attach the lamp, Powerbank, cables and other accessories. On the outside, a practical handle and loops for attachment to a belt or backpack ensure optimal portability. (Size 200mm x 135mm x 72mm)
24,90 € (MSRP)



NEW

Item no. 502264

Case Type B

With this high-quality, **fabric-covered hard case**, the Ledlenser lamp and accessories are always safely stored and protected from dust and external influences. Inside there are elastic loops and a mesh pocket to stow the lamp, Powerbank and other accessories. (Size 200mm x 135mm x 72mm)
29,90 € (MSRP)



Item no. 502238 **Color Filter Sets**
Color filter set
19,90 € (MSRP)



Item no. 502269 **Leather Pouch**
leather pouch
19,90 € (MSRP)



D14.2

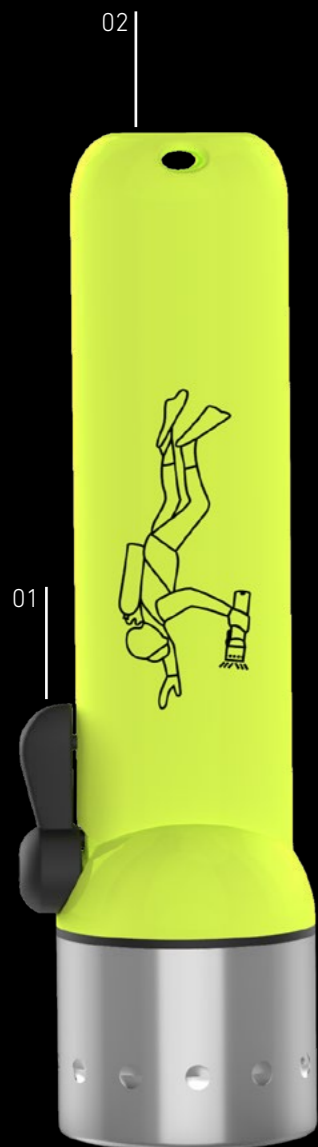

- 01 – For left and right-handers: **2-way Magnet Switch**
- 02 – Shock and corrosion-resistant protects it as well as water proof casing



D14.2

LED	
LED-Configuration	1x High Power LED
Light Functions	Power / Low Power
Luminous flux ¹ (lm)	400 / 60
Beam Distance ¹ (m)	200 / 80
Run Time ¹ (h)	2 / 15
BATTERY AND CASE	
Battery	4x Mignon (AA) Alkaline 1,5V
Battery Capacity ² (Wh / mAh)	-
Rechargeable	No
Charging Time ⁵ (min)	-
IP Level	IPX8
SIZE AND WEIGHT	
Length (mm)	161,5
Head diameter (mm)	42
Weight incl. Battery (g / oz)	233 / 8,2
TECHNOLOGY	
Temperature Control	●
More features	Constant Light, Low Battery Warning
PACKAGING	
Item no. Box / GTIN	9114 / 4029113911405
Item no. Blister / GTIN	9214 / 4029113921459
Contents (Box)	1 set of batteries, lanyard
Price (MSRP) in €	69,90
OPTIONAL ACCESSORIES	
	500958 Signal Cone 42mm
	500980 4x AA Alkaline Ionic

^{1,2} Information on page 184



SHINES LONGER THAN
THE LONGEST DIVE



— OUTDOOR & SPORTS HEADLAMPS

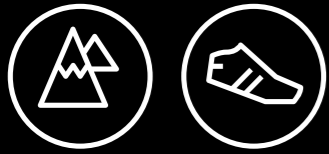

AS UNIQUE AS THOSE
WHO WEAR THEM

 LEDLENSER



H19R SIGNATURE



THE NEW H-SERIES THE QUEEN OF LIGHT

NEW

☀️ 4000 lm¹
📡 330 m¹
🕒 20 h¹

Bluetooth®

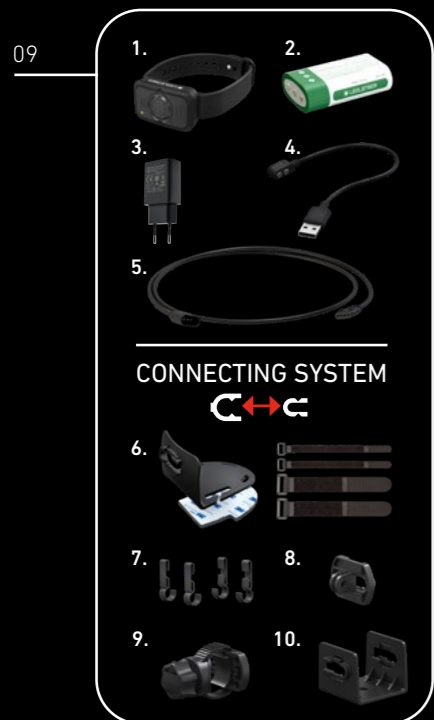
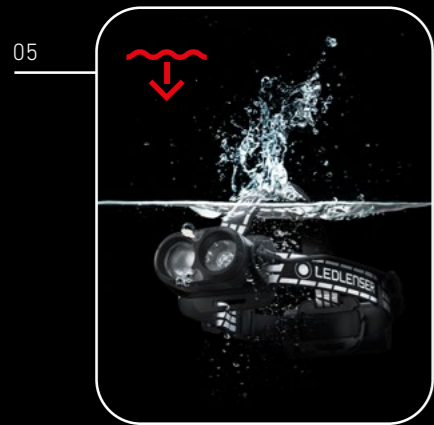

- 01 – Fusion Beam** – individually adjustable flood and spotlight for a unique light image with perfect illumination
- 02 – Multi-Core Optics** – homogeneous light image through special faceting of the lens
- 03 – Ledlenser Connect app and Bluetooth® remote control** enable personalization and remote control of the light functions
- 04 – Optisense Technology** – automatic adaptation to the light conditions thanks to the integrated sensor
- 05 – Extreme dust and water protection (IP68)**
- 06 – Additional red light** to maintain night vision
- 07 – Stepless swivel mechanism** for vertical alignment of the light cone
- 08 – Ledlenser Connecting System** – an interface for many accessory parts (see page 162)
- 09 – Additional content:** 1. Bluetooth® remote control, 2. battery, 3. USB power adapter, 4. Magnetic charging cable, 5. Extension cable 6. Helmet connecting kit, 7. Helmet clips, 8. GoPro Adapter, 9. Universal holder, 10. Stand holder ▶ Supplied in a soft case
- 10 – Reflective headband**

¹⁻⁷ Information on page 184

H-SERIES SIGNATURE

NEW

THE ULTIMATE LIGHTING
FOR THE HIGHEST
DEMANDS



LED	H7R SIGNATURE	H19R SIGNATURE
LED-Configuration	1x Xtreme LED	1x Xtreme LED
Light Functions	Boost / Power / Low Power (+ Strobe, Positon, SOS and Blink)	Boost / Power / Mid Power / Low Power (+ Strobe, Positon, SOS and Blink)
Luminous flux ¹ (lm)	1200 / 700 / 15	4000 / 1800 / 800 / 200
Beam Distance ¹ (m)	260 / 220 / 25	330 / 250 / 150 / 80
Run Time ¹ (h)	- / 3,5 / 65	- / 3,5 / 7 / 20
Color temperature (K)	6500	6500
Color rendering index (CRI)	80	80
BATTERY AND CASE		
Battery	1x 21700 Li-ion Battery 3,7V	1x Li-ion Batterypack 7,4V
Battery Capacity ² (Wh / mAh)	17,76 / 4800	35,52 / 4800
IP Level	IP67	IP68
Rechargeable	Yes	Yes
Charging Time ⁵ (min)	210	330
Drop height (m)	1,5	1,5
SIZE AND WEIGHT		
Head diameter (mm)	41	68
Weight incl. Battery (g / oz)	259 / 9,1	374 / 13,2
TECHNOLOGY		
Fusion Beam		●
Flex Sealing Technology	●	
Magnetic Charge System	●	●
Temperature Control	●	●
Advanced Focus System	●	
More features	Cooling Technology, Emergency Light, Bluetooth®, Dimmable, Transportation Lock, Flicker-free, Memory Mode, Backup Mode, Battery Indicator, Charge Indicator, Low Battery Warning, Constant Light	Mutli-Core Optics, Red Light, Optisense, Cooling Technology, Emergency Light, Bluetooth®, Dimmable, Transportation Lock, Flicker-free, Memory Mode, Backup Mode, Battery Indicator, Charge Indicator, Low Battery Warning, Constant Light
PACKAGING		
Item no. Box / GTIN	502197 / 4058205021081	502198 / 4058205021111
Contents Soft Case	1 set of batteries, helmet clips, GoPro adapter, helmet holder, velcro fasteners, adhesive pads, magnetic charging cable, tripod holder, USB power adapter, universal holder, extension cable	1 set of batteries, Bluetooth® remote control, helmet clips, GoPro adapter, helmet holder, Velcro fasteners, magnetic charging cable, tripod holder, USB power adapter, universal holder, Extension cables, adhesive pads
Price (MSRP) in €	149,00	299,00

Accessories on page 162

¹⁻⁶ Information on page 184

THE NEW H-SERIES CORE FROM PAGE 74

THE NEW H-SERIES WORK FROM PAGE 104

ACCESSORIES

HEADLAMPS

H-SERIES SIGNATURE

NEW

LEDLENSER CONNECTING SYSTEM

MODEL	H7R SIGNATURE	H19R SIGNATURE	Item no.	MSRP (€)
GoPro Adapter Type D NEW	•	•	502246	7,90
Tripod Adapter Type D NEW	•	•	502247	9,90
Belt Clip Type A NEW	•	•	502253	6,90
Helmet Connecting Kit H NEW	•	•	502314	14,90
Universal Mounting Bracket Type E NEW	•	•	502256	12,90

Thanks to the integrated slide the lamp is immediately compatible with various additional brackets



Item no. 502246
GoPro Adapter
Compatible with almost all GoPro systems and accessories
7,90 € (MSRP)

Item no. 502253
Belt Clip Type A
Belt clip for lights and batteries
6,90 € (MSRP)

Item no. 502314
Helmet Connecting Kit H
Stable helmet holder system for a wide variety of helmet models
14,90 € (MSRP)

Item no. 502256
Universal Mounting Bracket
Stable universal fastening for rods
12,90 € (MSRP)

Item no. 502247
Tripod Adapter
Tripod adapter
9,90 € (MSRP)



Item no. 502311
Wireless Remote Control Type A
Ledlenser meets Bluetooth®: With this handy remote control, compatible Ledlenser lights with Bluetooth® function can be controlled remotely at the touch of a button. The remote control is linked to the headlamp via the Ledlenser Connect app and can then e.g. can be worn on the wrist, handlebars or ski / hiking poles to have the perfect light within easy reach
34,90 € (MSRP)

NEW

Item no. 502312
Extension Cable
Practical extension cable (120 cm) that is plugged in between the lamp head and the battery box - so the battery can easily be stowed in the backpack
9,90 € (MSRP)

NEW



Item no. 502411
Bluetooth® 2x 21700 Batterybox
Upgrade to smart control: Bluetooth® Li-ion battery box for use with the Ledlenser Connect app or with the available remote control
59,90 € (MSRP)

NEW

Item no. 502265
Magnetic Charging Cable
Magnetic charging cable with standard USB-A connector
6,90 € (MSRP)

NEW

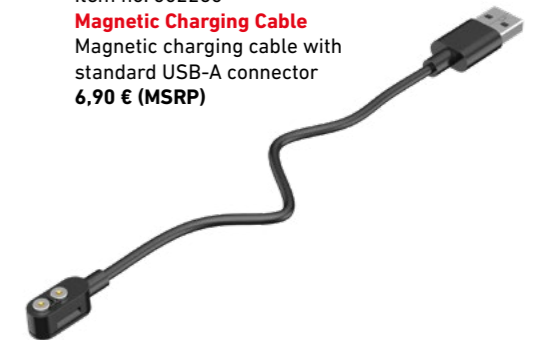



ACCESSORIES POWER SUPPLY / COLOR FILTERS AND MORE

MODEL	H7R SIGNATURE	H19R SIGNATURE	Item no.	MSRP (€)
Wireless Remote Control Type A NEW	•	•	502311	34,90
Color Filter Set 40mm NEW	•		502308	18,90
Helmet Band Fixing Clips Type A NEW	•		502313	4,90
Transparent Silicone Headband Type A NEW	•	•	502451	9,90
Headband with Overheadband CORE NEW	•	•	502469	9,90
Headband with Overheadband WORK NEW	•	•	502470	9,90
Headband with Overheadband SIGNATURE NEW	•	•	502471	12,90
Magnetic Charging Cable Type A NEW	•	•	502265	6,90
Extension Cable Type C NEW	•	•	502312	9,90
USB Adapter 2.4A NEW	•	•	502271	14,90
21700 Li-ion Rechargeable Battery 4800mAh NEW	•		502262	24,90
2x 21700 Li-ion Rechargeable Battery Pack		•	502310	39,90
Bluetooth® 21700 Batterybox NEW	•		502410	49,90
Bluetooth® 2x 21700 Batterybox NEW	•	•	502411	59,90

MH11 



 1000 lm¹
 320 m¹
 100 h¹



- 01 – **Ledlenser Connect App** offers direct control and programmable light functions
- 02 – **Optisense Technology** automatically adjusts to surrounding light conditions
- 03 – **Advanced Focus System** – stepless focusing
- 04 – **Multicolor LED** in red, green and blue for use at night, hunting and fishing
- 05 – Smooth **Swivel Mechanism** allows for a click-less light tilt in an upward or downward motion
- 06 – **Innovatives Mounting System** enables quick detachment of the lamp head from the band to use as a handheld light
- 07 – **Magnetic Charging System** for fast and easy battery charging

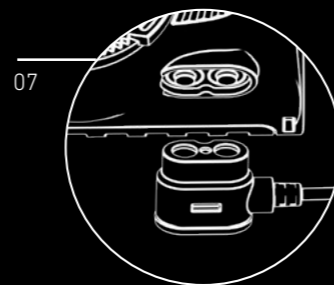
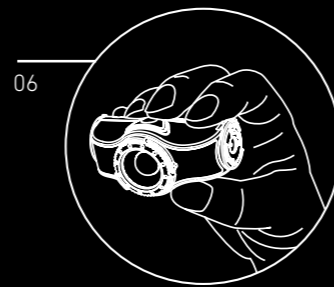

¹⁻⁷ Information on page 184

INTELLIGENT HEADLAMP FOR ADVENTURERS



MH11-Product video



Connect-App-Video



MH-SERIES



MH3

MH4

LED		
LED-Configuration	1x High Power LED	1x High Power LED, 1x Red LED
Light Functions	Power / Low Power	Power / Low Power
Luminous flux ¹ (lm)	200 / 20	400 / 20
Beam Distance ¹ (m)	130 / 40	180 / 40
Run Time ¹ (h)	4,5 / 35	4 / 35
BATTERY AND CASE		
Battery	1x Mignon (AA) Alkaline 1,5V	1x 14500 Li-ion Battery 3,7V
Battery Capacity ² (Wh / mAh)	-	2,77 / 750
Rechargeable	No	Yes
Charging Time ⁵ (min)	-	150
IP Level	IP54	IP54
SIZE AND WEIGHT		
Head diameter (mm)	31	31
Weight incl. Battery (g / oz)	92 / 3,2	94 / 3,3
TECHNOLOGY		
Smart Light Technology	●	●
Rapid Focus	●	●
Dual Power Source	●	●
Advanced Focus System	●	●
Magnetic Charge System		●
More features	Low Battery Warning	Low Battery Warning, Battery Indicator, Charge Indicator, Red Light
PACKAGING		COLOR VARIATIONS
Item no. Window Box / GTIN	502148 orange / 4058205019729	502151 black / 4058205020121
Item no. Window Box / GTIN	502149 yellow / 4058205019750	502152 sand / 4058205019545
Item no. Window Box / GTIN	502150 blue / 4058205019781	
Item no. Window Box / GTIN	501597 black / 4058205014656	
Item no. Window Box / GTIN	500948 white / 4058205012164	
Contents Box	1 set of batteries	1 set of batteries, magnetic charging cable
Price (MSRP) in €	29,90	39,90
OPTIONAL ACCESSORIES		
	0374 Elastic Reflecting Headband Type A	502093 Powercase (siehe S.137)
	500986 Charging station	0374 Elastic Reflecting Headband Type A
more accessories on page 174	500985 14500 Li-ion rech. Battery	0380 USB Car Charger



MH5

LED-Configuration	1x High Power LED, 1x Red LED
Light Functions	Power / Low Power
Luminous flux ¹ (lm)	400 / 20
Beam Distance ¹ (m)	180 / 40
Run Time ¹ (h)	4 / 35
BATTERY AND CASE	
Battery	1x 14500 Li-ion Battery 3,7V
Battery Capacity ² (Wh / mAh)	2,77 / 750
Rechargeable	Yes
Charging Time ⁵ (min)	150
IP Level	IP54
SIZE AND WEIGHT	
Head diameter (mm)	31
Weight incl. Battery (g / oz)	94 / 3,3
TECHNOLOGY	
Smart Light Technology	●
Rapid Focus	●
Dual Power Source	●
Advanced Focus System	●
Magnetic Charge System	●
More features	Low Battery Warning, Battery Indicator, Charge Indicator, Red Light
PACKAGING	
Item no. Window Box / GTIN	502143 orange / 4058205019576
Item no. Window Box / GTIN	502144 yellow / 4058205019606
Item no. Window Box / GTIN	502145 blue / 4058205019811
Item no. Window Box / GTIN	502147 black / 4058205019873
Item no. Window Box / GTIN	502146 white / 4058205019842
Contents Box	1 set of batteries, magnetic charging cable
Price (MSRP) in €	39,90
OPTIONAL ACCESSORIES	
	502093 Powercase (siehe S.137)
	0374 Elastic Reflecting Headband Type A
	0380 USB Car Charger

MH5 ^{rechargeable}



- 01 – Advanced Focus System** – stepless focusing
- 02 – Innovatives Mounting System** enables easy to remove and put on lamp head and battery
- 03 – Numerous attachment options** using metal clips on the lamp head
- 04 – Red light function** to maintain the night vision ability
- 05** – Variable **swivel mechanism** for aiming the light cone
- 06 – Dual Power Source** – rechargeable or primary battery, this technology allows for both
- 07** – Convenient and safe charging of the batteries thanks to **Magnetic Charge System**
- 08 – Battery indicator** and **charge indicator**

¹⁻⁷ Information on page 184





MH-SERIES

ENGINEERED
LIGHT, EVEN IN
THE WILD

LED

LED-Configuration
Light Functions
Luminous flux ¹ (lm)
Beam Distance ¹ (m)
Run Time ¹ (h)

BATTERY AND CASE

Battery
Battery Capacity ²
Rechargeable
Charging Time ⁵ (min)
IP Level

SIZE AND WEIGHT

Head diameter (mm)
Weight incl. Battery (g / oz)

TECHNOLOGY

Smart Light Technology
Rapid Focus
Dual Power Source
Advanced Focus System
Magnetic Charge System
Optisense Technology

More features

PACKAGING

Item no. Window Box / GTIN
Item no. Window Box / GTIN
Item no. Window Box / GTIN
Item no. Window Box / GTIN
Item no. Window Box / GTIN
Contents Box

Price (MSRP) in €

Optional accessories on page 174





MH7	MH8	MH11
1x Xtreme LED, 1x Red LED	1x Xtreme LED, 1x Multicolor LED	1x Xtreme LED, 1x Multicolor LED
Boost / Power / Mid Power / Low Power (+ Blink)	Boost / Power / Mid Power / Low Power (+ Blink)	Boost / Power / Mid Power / Low Power (+ Blink, S.O.S., Strobe)
600 / 400 / 170 / 20	600 / 400 / 170 / 20	1000 / 750 / 300 / 10
200 / 180 / 120 / 40	200 / 180 / 120 / 40	320 / 300 / 200 / 30
- / 7 / 10 / 60	- / 7 / 10 / 60	- / 4 / 8 / 100
1x Li-ion Batterypack 3,7V	1x Li-ion Batterypack 3,7V	1x 18650 Li-ion Battery 3,6V
5,73 / 1550	5,73 / 1550	11,52 / 3200
Yes	Yes	Yes
270	270	420
IP54	IP54	IP54
31	31	40
139 / 4,9	139 / 4,9	179 / 6,3
●	●	●
●	●	●
●	●	●
●	●	●
●	●	●
●	●	●
Cooling Technology, Energy Saving, Constant Light, Low Battery Warning, Charge Indicator, Battery Indicator, Red Light, Transportation Lock	Cooling Technology, Energy Saving, Constant Light, Low Battery Warning, Charge Indicator, Battery Indicator, Red Light, Green Light, Blue Light, Transportation Lock	Cooling Technology, Energy Saving, Constant Light, Low Battery Warning, Charge Indicator, Battery Indicator, Red Light, Green Light, Blue Light, Transportation Lock, Bluetooth®, Dimmable, Memory Mode
502153 orange / 4058205019903	502156 black / 4058205019996	502166 orange / 4058205020091
502154 yellow / 4058205019934	502157 sand / 4058205020022	500996 black / 4058205013833
502155 blue / 4058205019965		
501599 black / 4058205014700		
500990 white / 4058205013635		
1 set of batteries, magnetic charging cable	1 set of batteries, magnetic charging cable	1 set of batteries, magnetic charging cable, pouch
59,90	69,90	149,00

1-7 Information on page 184

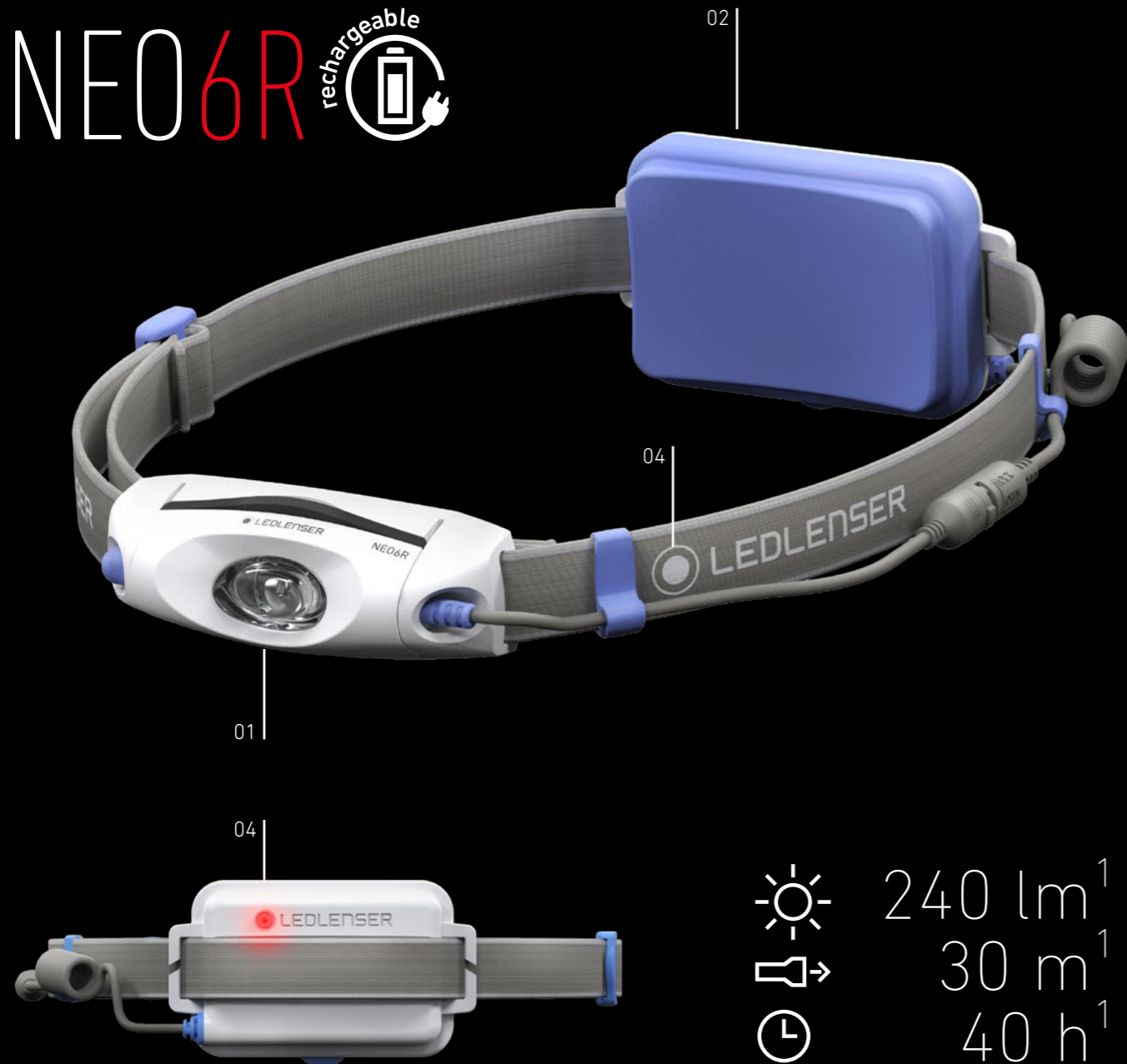

NEO6R



 240 lm¹
 30 m¹
 40 h¹

- 01** – Innovative optics and **swivel head for one optimal illumination** of the route
- 02** – **Li-ion-Battery** – conveniently rechargeable via micro USB
- 03** – **Two energy modes** – Energy Saving for a long period of time and Constant Light for constant light output
- 04** – Visible all around - **red flashing rear light** and **reflective headband** (refl. headband not with the black MODEL)
- 05** – High **dust and water protection (IP57)**
- 06** – **Backup Mode** – more than one hour remaining from the first low battery warning
- 07** – Suitable for groups – can be used as a chest lamp with the supplied chest strap reducing the mutual glare in running groups



CUSTOMIZED LIGHT FOR JOGGERS



NEO-SERIES



NEO4

NEO6R

LED		
LED-Configuration	1x Power LED	1x Power LED
Light Functions	Power / Low Power (+ Blink)	Power / Low Power (+ Blink)
Luminous flux ¹ (lm)	240 / 20	240 / 20
Beam Distance ¹ (m)	30 / 10	30 / 10
Run Time ¹ (h)	6 / 40	6 / 40
BATTERY AND CASE		
Battery	3x Micro (AAA) Alkaline 1,5V	1x Li-ion Batterypack 3,7V
Battery Capacity ² (Wh / mAh)	-	5,18 / 1400
Rechargeable	No	Yes
Charging Time ⁵ (min)	-	240
IP Level	IP57	IP57
SIZE AND WEIGHT		
Head diameter (mm)	70	70
Weight incl. Battery (g / oz)	100 / 3,5	95 / 3,4
TECHNOLOGY		
Smart Light Technology	●	●
Rapid Focus	●	●
Temperature Control	●	●
Wide Beam	●	●
Advanced Focus System	●	●
More features	Energy Saving, Constant Light, Low Battery Warning, Rear Light, Transportation Lock	Energy Saving, Constant Light, Low Battery Warning, Charge Indicator, Rear Light, Transportation Lock
PACKAGING		COLOR VARIATIONS
Item no. Window Box / GTIN	500914 blue / 4058205010375	500918 blue / 4058205010498
Item no. Window Box / GTIN	500915 green / 4058205010405	500919 green / 4058205010528
Item no. Window Box / GTIN	500916 pink / 4058205010436	500920 pink / 4058205010559
Item no. Window Box / GTIN	500982 black / 4058205013581	500983 black / 4058205013550
Contents Box	1 set of batteries	1 set of batteries, Chest strap, USB cable
Price (MSRP) in €	29,90	49,90
OPTIONAL ACCESSORIES		
	0332 Pouch Type H	0332 Pouch Type H
more accessories on page 174	500981 4x AAA Alkaline Ionic	



NEO10R

LED	1x Xtreme LED
Light Functions	Power / Mid Power / Low Power
Luminous flux ¹ (lm)	600 / 250 / 10
Beam Distance ¹ (m)	150 / 100 / 20
Run Time ¹ (h)	10 / 15 / 120
BATTERY AND CASE	
Battery	1x 18650 Li-ion Battery 3,6V
Battery Capacity ² (Wh / mAh)	11,52 / 3200
Rechargeable	Yes
Charging Time ⁵ (min)	360
IP Level	IP54
SIZE AND WEIGHT	
Head diameter (mm)	36
Weight incl. Battery (g / oz)	179 / 6,3
TECHNOLOGY	
Smart Light Technology	●
Rapid Focus	●
Temperature Control	●
Wide Beam	●
Advanced Focus System	●
More features	Energy Saving, Constant Light, Charge Indicator, Low Battery Warning, Rear Light, Transportation Lock
PACKAGING	
Item no. Window Box / GTIN	500917 blue / 4058205010467
Item no. Window Box / GTIN	500984 black / 4058205013529
Contents Box	1 set of batteries, Chest strap, USB cable, Extension cable
Price (MSRP) in €	99,90
OPTIONAL ACCESSORIES	
	0380 USB Car Charger

NEO10R

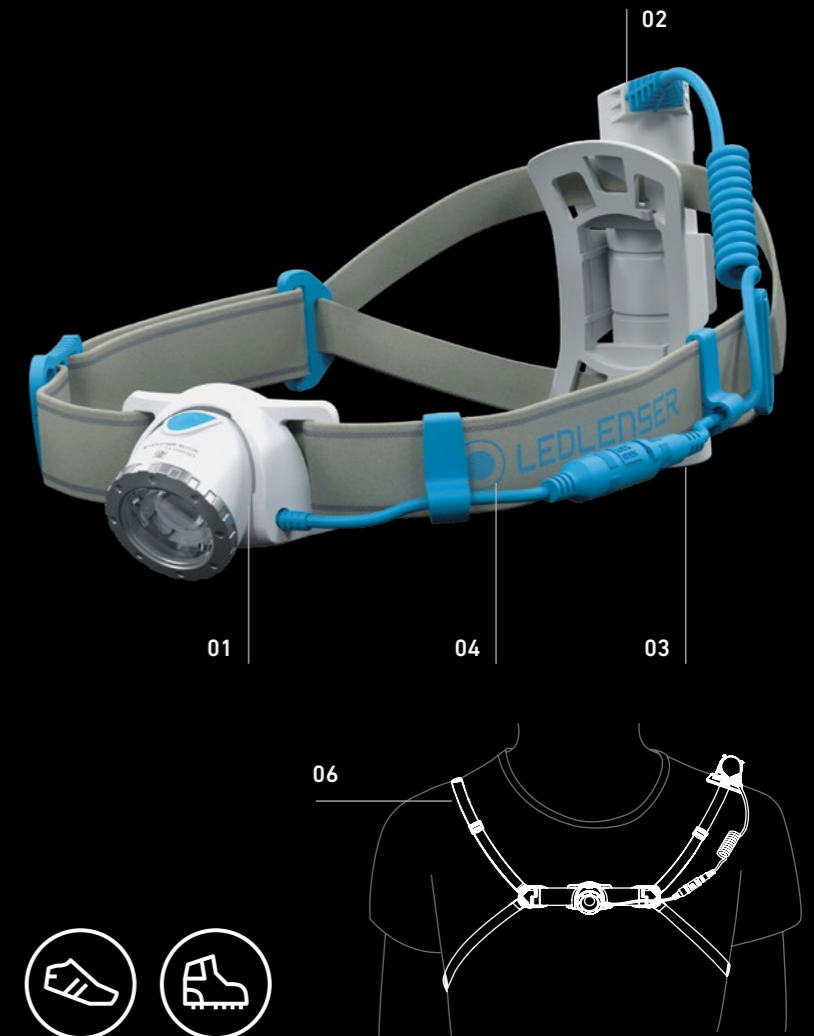

- 01 – Swiveling and focusable lamp head** for optimal illumination
- 02 – Vertical battery box** for a secure hold and comfort when running
- 03 – Batterybox can be easily clipped off** and can be used in combination with the included extension cables to be stowed away elsewhere
- 04 – Visible all around** - red glowing rear light and reflective headband (refl. headband only with the blue color variant)
- 05 – Two energy modes** - Energy Saving for long running time and Constant Light for constant light output
- 06 – Suitable for groups** – can be used as a **chest lamp** with the supplied chest strap reducing the mutual glare in running groups

ACCESSORIES HEADLAMPS

MODEL	MH3	MH4	MH5	MH7	MH8	MH11	NEO4			NEO6R	NEO10R	Item no.	MSRP (€)
Powercase NEW		•	•	•	•							502093	49,90
Powerbank Flex3 NEW												502126	34,90
Powerbank Flex7 NEW												502125	54,90
Batterybox7 NEW												502128	29,90
Helmet Connecting Kit Type D	•	•	•									502220	9,90
Helmet Connecting Kit Type E				•	•							502221	9,90
Helmet Connecting Kit Type F						•						502222	9,90
Helmet Connecting Kit Type G	•	•	•	•	•	•						502223	14,90
Helmet Band Fixing Clips Type A NEW	•	•	•	•	•	•					•	502313	4,90
Universal Mounting Bracket Type D												502052	19,90
Pouch Type H							•			•		0332	12,90
Reflecting Headband Type A		•	•									0374	12,90
USB Car Charger		•	•	•	•	•				•	•	0380	9,90
USB Power Supply and Adapter Cable										•	•	0389	14,90
USB Adapter 2.4A		•	•	•	•	•						502271	14,90
Li-Ion Rechargeable Battery Pack 3,7V 1550 mAh				•	•							500987	17,90
4x AAA Alkaline Ionic							•					500981	3,49
4x AA Alkaline Ionic	•	•	•	•	•							500980	3,49
14500 Li-ion Rechargeable Battery 3,7V 750 mAh	•	•	•									500985	12,90
Charging station and 14500 Li-ion Rechargeable Battery	•	•	•									500986	18,90
18650 Li-ion Rechargeable Battery 3,6V 3200 mAh							•				•	501001	24,90

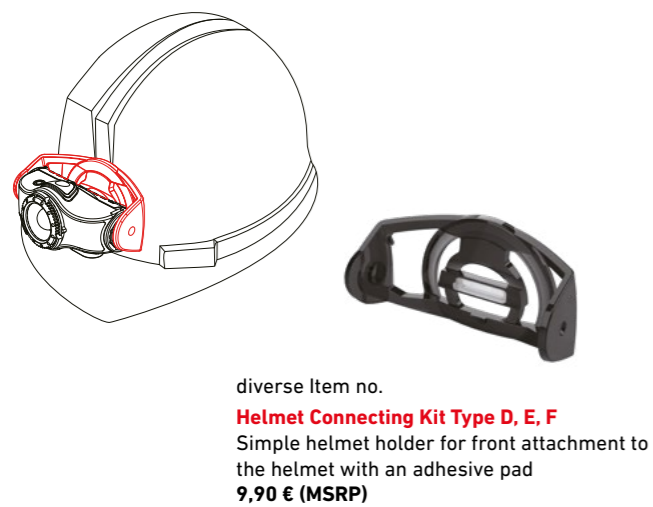

POWERCASE **NEW**

Transport safely, charge conveniently

- Safe, secure transportation and protection for your headlamp
- Internal magnetic charging for compatible Ledlenser headlamps
- Powerbank (5,000 mAh) with USB-A connection
- Battery charging indicator

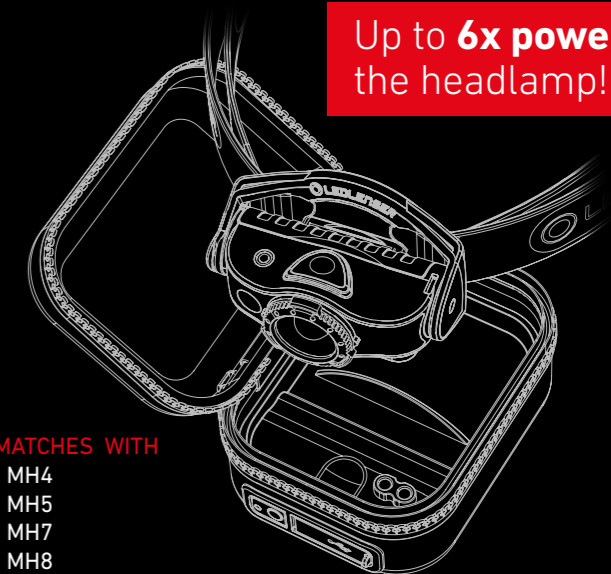

Up to **6x power** for the headlamp!

MATCHES WITH

- > MH4
- > MH5
- > MH7
- > MH8
- > iH5R
- > iH9R

POWERCASE	
Weight incl. Battery (g)	219
Capacity ² (Wh / mAh)	18,5 / 5000
Charging Time ⁵ (min)	180
Item no.	502093
Contents	Snap hook, USB cable
Price, MSRP (€)	49,90



— OUTDOOR & SPORTS LANTERNS



 LEDLENSER

ML6 CONNECT WL



NEW

☀️ 750 lm¹
🕒 180 h¹



- 01** – **Micro Prism Technology – patented⁴ lens technology** for glarefree light and high energy efficiency
- 02** – **Ledlenser Connect App** and wireless **Bluetooth® remote control** enable personalization and remote control of the light functions
- 03** – **Infinitely dimmable** via three-way switch
- 04** – **Powerbank function** with USB connection for charging electronic devices
- 05** – **Red light** to maintain night vision ability
- 06** – Rubber hook for hanging the light, integrated magnet for mounting it on metal surfaces, and a removable stand with a built-in metal hook that can be flipped out to provide more light mounting options
- 07** – Convenient and safe charging of the batteries thanks to the **Magnetic Charge System**
- 08** – Integrated battery and charge status display

Bluetooth®

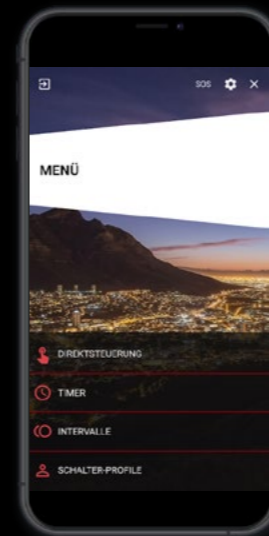

LEDLENSER CONNECT APP

GLARE-FREE 360° ENLIGHTENMENT WITH REMOTE CONTROL



ML-SERIES



NEW

ML4

ML4 Warm Light

LED		
LED-Configuration	9x Power LED	9x Power LED
Light Functions	Boost / Power / Mid Power / Low Power (+ Blink)	Boost / Power / Mid Power / Low Power (+ Blink)
Luminous flux ¹ (lm)	300 / 150 / 50 / 5	300 / 150 / 50 / 5
Beam Distance ¹ (m)	-	-
Run Time ¹ (h)	- / 2,5 / 8 / 45	- / 2,2 / 7 / 40
BATTERY AND CASE		
Battery	1x 14500 Li-ion Battery 3,7V	1x 14500 Li-ion Battery 3,7V
Battery Capacity ² (Wh / mAh)	2,77 / 750	2,77 / 750
Rechargeable	Yes	Yes
Charging Time ⁵ (min)	150	150
IP Level	IP66	IP66
SIZE AND WEIGHT		
Diameter (mm)	34,5	34,5
Length (mm)	97	97
Weight incl. Battery (g / oz)	71 / 2,5	71 / 2,5
TECHNOLOGY		
Smart Light Technology	●	●
Micro Prism Technology	●	●
Temperature Control	●	●
Powerbank-Funktion		
Magnetic Charge System	●	●
Dual Power Source	●	●
More features	Low Battery Warning, Charge Indicator, Battery Indicator, Transportation Lock, Red Light	Low Battery Warning, Charge Indicator, Battery Indicator, Transportation Lock, Red Light
PACKAGING		
Item no. Window Box / GTIN	502053 / 4058205017886	502231 / 4058205022125
Contents Box	1 set of batteries, magnetic charging cable	1 set of batteries, magnetic charging cable
Price (MSRP) in €	39,90	39,90
OPTIONAL ACCESSORIES		
	502271 USB Adapter 2.4A	502271 USB Adapter 2.4A
more accessories on page 182	0380 USB Car Charger	0380 USB Car Charger



NEW



ML6

ML6 Warm Light

ML6 Connect WL

LED			
LED-Configuration	18x Power LED	18x Power LED	18x Power LED
Light Functions	Boost / Power / Low Power (+ Blink, Pulse, S.O.S., Strobe)	Boost / Power / Low Power (+ Blink, Pulse, S.O.S., Strobe)	Boost / Power / Mid Power / Low Power (+ Blink, Pulse, Position, Strobe, S.O.S., Alpines Notsignal)
Luminous flux ¹ (lm)	750 / 550 / 5	750 / 550 / 5	750 / 550 / 100 / 5
Beam Distance ¹ (m)	-	-	-
Run Time ¹ (h)	- / 4 / 240	- / 3,5 / 200	- / 3,5 / 12 / 180
BATTERY AND CASE			
Battery	1x 18650 Li-ion Battery 3,6V	1x 18650 Li-ion Battery 3,6V	1x 18650 Li-ion Battery 3,6V
Battery Capacity ² (Wh / mAh)	11,52 / 3200	11,52 / 3200	11,52 / 3200
Rechargeable	Yes	Yes	Yes
Charging Time ⁵ (min)	300	300	300
IP Level	IP66	IP66	IP66
SIZE AND WEIGHT			
Diameter (mm)	42	42	45
Length (mm)	178	178	178
Weight incl. Battery (g / oz)	280 / 9,9	280 / 9,9	260 / 9,2
TECHNOLOGY			
Smart Light Technology	●	●	●
Micro Prism Technology	●	●	●
Temperature Control	●	●	●
Powerbank-Funktion	●	●	●
Magnetic Charge System			●
Dual Power Source			●
More features	Low Battery Warning, Charge Indicator, Battery Indicator, Dimmable, Transportation Lock, Red Light, Memory Mode	Low Battery Warning, Charge Indicator, Battery Indicator, Dimmable, Transportation Lock, Red Light, Memory Mode	Low Battery Warning, Charge Indicator, Battery Indicator, Dimmable, Transportation Lock, Red Light, Bluetooth®, Memory Mode, Emergency Light
PACKAGING			
Item no. Window Box / GTIN	500929 / 4058205011259	502084 / 4058205017916	502201 / 4058205021203
Contents Box	1 set of batterie, stand, transport bag, USB cable	1 set of batterie, stand, transport bag, USB cable	1 set of batterie, stand, transport bag, magnetic charging cable
Price (MSRP) in €	79,90	79,90	99,90
OPTIONAL ACCESSORIES			
	500993 Tripod Type A	500993 Tripod Type A	500993 Tripod Type A
	502126 Flex3 Powerbank NEW	502126 Flex3 Powerbank NEW	502126 Flex3 Powerbank NEW



ACCESSORIES

LANTERNS

MODEL	ML4	ML4 Warm Light	Item no.	MSRP (€)
14500 Li-ion rechargeable battery 750 mAh	●	●	500985	12,90
4x AA Alkaline Ionic	●	●	500980	3,49
Charging station and 14500 li-ion rechargeable battery	●	●	500986	18,90
USB Car Charger	●	●	0380	9,90
USB Power Supply and Adapter Cable	●	●	0389	14,90

MODEL	ML6	ML6 Warm Light	ML6 Connect WL	Item no.	MSRP (€)
Tripod Type A	●	●	●	500993	19,90
18650 Li-ion Rechargeable Battery 3,6V 3200 mAh	●	●	●	501001	24,90
USB Car Charger	●	●	●	0380	9,90
USB Power Supply and Adapter Cable	●	●	●	0389	14,90
Flex3 Powerbank NEW	●	●	●	502126	34,90
Flex7 Powerbank NEW	●	●	●	502125	54,90
Batterybox7 NEW	●	●	●	502128	29,90



Item no. 502126
Powerbank Flex3
More information on page 40
34,90 € (MSRP)

NEW



Item no. 502125
Powerbank Flex7
More information on page 40
54,90 € (MSRP)

NEW



Item no. 502128
Batterybox7
More information on page 40
29,90 € (MSRP)

NEW



NOTES

The information pertaining to package contents, appearance, performance, dimensions and weight corresponds to the information available at the time of publication. In the interest of product development, we reserve the right to change package contents, appearance, design and color without prior notice. Product images may vary from the actual products and may show optional accessories which can be purchased separately. Errors and misprints excepted.

1) Measurements according to ANSI FL1 on the respective setting. If no setting is explicitly indicated, the values refer to luminous flux (Lumen/lm) and beam distance (meters/m) on the highest setting and to the run time (hours/h) on the lowest setting. If the light is equipped with color LED(s), the measurements indicated apply to white light or white LED. A boost function (if applicable) can be used several times, but only for short periods of time. If the light has different energy modes, measurement is based on "energy saving mode."

2) Calculated capacity value in watt-hours (Wh) or milliampere hours (mAh). This applies to the delivery state of the battery/ies inside the respective item, or for lights with rechargeable battery/ies, to the rechargeable battery/ies inside the product when fully charged.

3) EP Patent 1880139; US Patent 7,461,960

4) Two years warranty from the date of purchase, or seven years with online registration through our website. The warranty applies worldwide; legal warranty rights also apply. It covers defects in material and manufacture. Battery packs are guaranteed to work correctly for 24 months. This warranty does not cover products in the "Solidline" series, Ledlenser K1 and Ledlenser K2, as well as defective batteries, holsters, pouches, remote switches, color filters, imprints and surface coatings. The warrantor is Ledlenser GmbH & Co. KG, Kronenstr. 5-7, 42699 Solingen, Germany. For more information visit ledlenser.com/warranty

5) The average charging time of the batteries in the delivery state in minutes may vary depending on the power supply unit used.

6) Additional talk time using the example of an iPhone X when charging with the fully charged batteries contained in the content of the article in question.

7) EP-Patent 3376097

The Bluetooth® word mark and logos are registered trademarks owned by Bluetooth SIG, Inc. and any use of these by Ledlenser GmbH & Co. KG is under license

You can find our terms and conditions at www.ledlenser.com

Ledlenser GmbH & Co. KG
Kronenstraße 5–7, 42699 Germany, Deutschland
USt-IdNr.: DE815242425, Amtsgericht Wuppertal, HRA 23078
Personally liable partner:
Ledlenser Beteiligungs GmbH
Headquarters: Solingen, Deutschland
Amtsgericht Wuppertal, HRB 24774
Executive Director: Thomas Willing

LEDLENSER WE'RE LOOKING FORWARD TO PARTNERING WITH YOU

We are always looking for ways to improve how we can support you and your customers. We greatly appreciate any feedback you have on how we can build the Ledlenser brand together.

CONTACT MARKETING

Get answers to marketing questions and approval of marketing materials at: marketing@ledlenser.com

CONTACT TECHNICAL SUPPORT

Our team will help you with technical questions through direct and uncomplicated support: support@ledlenser.com

For customers from Austria: support@ledlenser.at

